

# EBIKE Connector



## EBBL battery interface circular connector

### Product features

- ✓ Fast connection straightly and directly.
- ✓ Auditory and visual feedback after connecting in place.
- ✓ High mechanical life.
- ✓ Beautiful appearance meet Ergonomic design.

### Application Scope

EBIKE battery interface connection

### EBBL Straight Plug/ EBL Right Angle Plug



### EBBL Socket



### EBBL Straight/right Angle Plug Dimensional Drawing

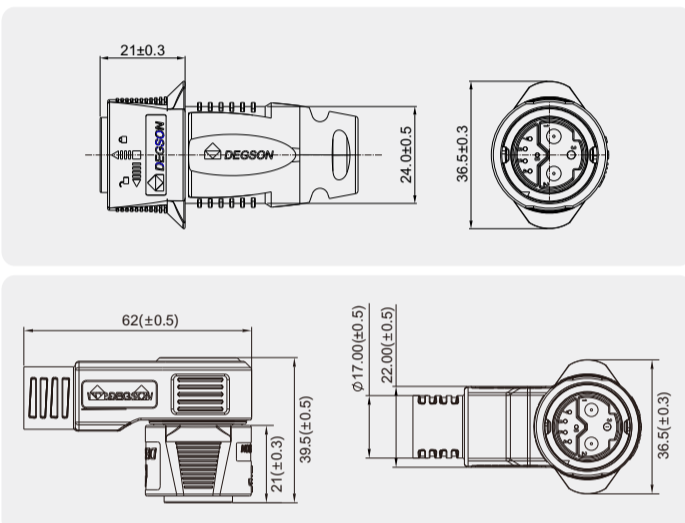

### EBBL Socket Dimensional Drawing

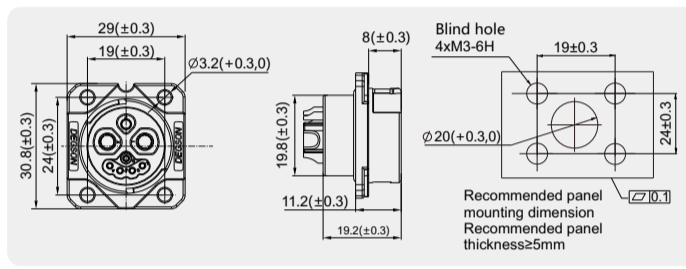

### Technical Data

Rated current	Power 50A, signal 2A	Wiring connection	Soldering
Rated voltage	110V DC	Salt spray resistance	Neutral salt spray 72h
Insulation resistance	≥100MΩ	Withstand voltage	500V AC
Flame retardant rating	UL94V-0	Mechanical life	≥3000times
Operating temperature	-40°C ~ +105°C	Extraction force	> 25N
IP grade	IP67 when mated, IP67 when only receptacle	Environmental protection	Meet RoHS

## EBC charging socket

### Product features

- ✓ Receptacle with cover flap can effectively protect the interface.
- ✓ High mechanical life.
- ✓ Beautiful appearance meet Ergonomic design.

### Application Scope

EBIKE battery interface connection

### EBC socket



### EBC socket



### EBC socket dimensional drawing

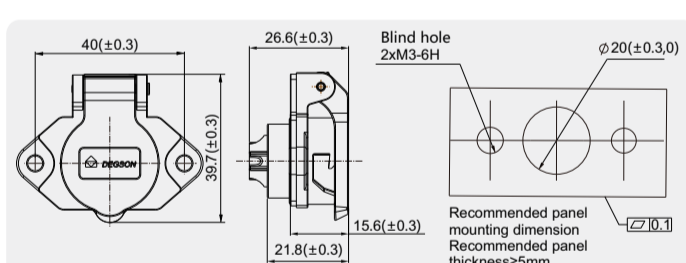

### Technical Data

Rated current	Power 50A, signal 2A	Wiring connection	Soldering
Rated voltage	110V DC	Salt spray resistance	Neutral salt spray 72h
Insulation resistance	≥100MΩ	Withstand voltage	500V AC
Flame retardant rating	UL94V-0	Mechanical life	≥3000times
Operating temperature	-40°C ~ +105°C	Extraction force	> 25N
IP grade	IP67 when mated, IP67 when only receptacle	Environmental protection	Meet RoHS

## EBBM battery interface circular connector

### Product features

- ✓ Fast connection straightly and directly.
- ✓ Auditory and visual feedback after connecting in place.
- ✓ High mechanical life.
- ✓ Beautiful appearance meet Ergonomic design.

### Application Scope

EBIKE battery interface connection

### EBBM right angle plug



### EBBM socket



### EBBM plug dimensional drawing

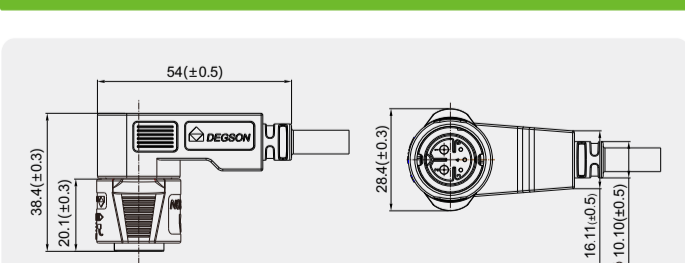

### EBBM socket dimensional drawing

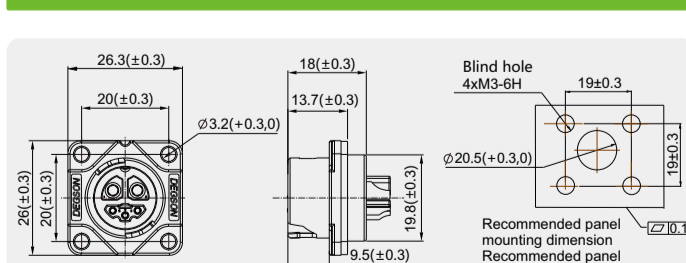

### Technical Data

Rated current	Power 50A, signal 2A	Wiring connection	Soldering
Rated voltage	110V DC	Salt spray resistance	Neutral salt spray 72h
Insulation resistance	≥100MΩ	Withstand voltage	500V AC
Flame retardant rating	UL94V-0	Mechanical life	≥3000times
Operating temperature	-40°C ~ +85°C	Extraction force	> 20N
IP grade	IP67 when mated, IP67 when only receptacle	Environmental protection	Meet RoHS

## EBBM power rectangular connector

### Product features

- ✓ Fast connection straightly and directly.
- ✓ Handle structure can be used to help unlock, when product pulled out.
- ✓ High mechanical life.
- ✓ Beautiful appearance meet Ergonomic design.

### EBBR straight/right angle plug



### EBBR plug dimensional drawing

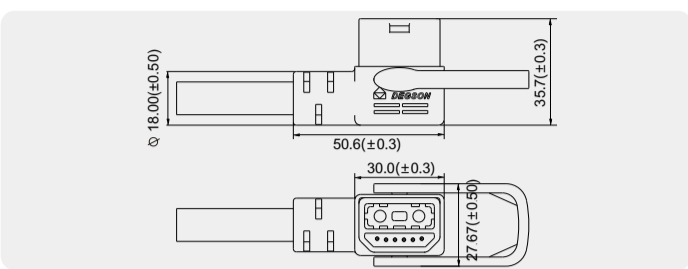

### Application Scope

EBIKE battery interface connection

### EBBR socket

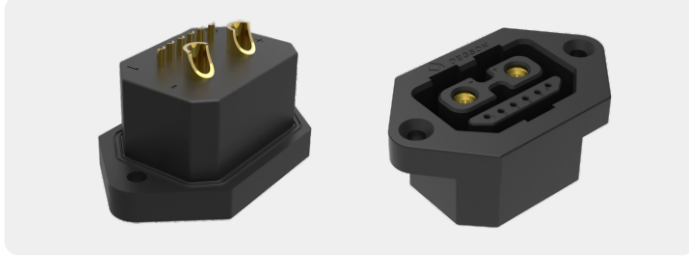

### EBBR socket dimensional drawing

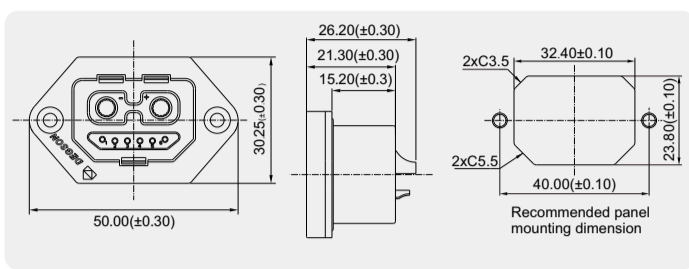

### Technical Data

Rated current	Power 50A, signal 2A	Wiring connection	Soldering
Rated voltage	110V DC	Salt spray resistance	Neutral salt spray 72h
Insulation resistance	≥100MΩ	Withstand voltage	500V AC
Flame retardant rating	UL94V-0	Mechanical life	≥3000 times
Operating temperature	-40°C ~ +105°C	Extraction force	> 30N
IP grade	IP67 when only receptacle	Environmental protection	Meet RoHS

## EBBF float exchange battery connector

### Product features

- ✓ The products are matched with each other and have the function of positive and negative insertion.
- ✓ The floating amount when the product inserted can compensate the gap between the vehicle body and the battery.
- ✓ Alignment and insertion of guide pin conveniently and fastly.
- ✓ High mechanical life.

### EBBF right angle plug

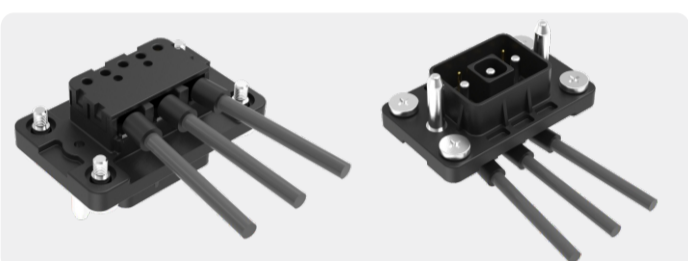

### EBBF plug dimensional drawing

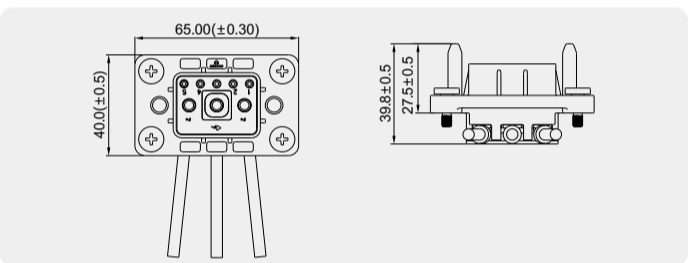

### Application Scope

EBIKE battery interface connection for cabinet

### EBBF socket



### EBBF socket dimensional drawing

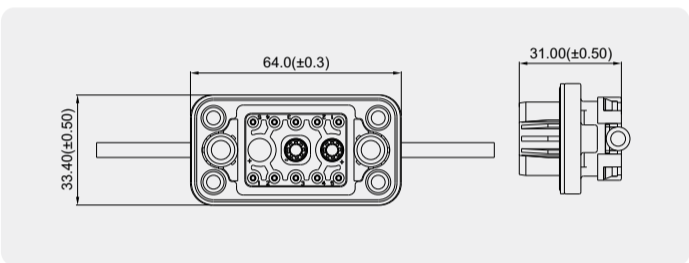

### Technical Data

Rated current	Power 50A, signal 2A	Wiring connection	Soldering
Rated voltage	72V DC	Salt spray resistance	Neutral salt spray 72h
Insulation resistance	≥500MΩ	Withstand voltage	1500V AC
Flame retardant rating	UL94V-0	Mechanical life	≥5000 times
Operating temperature	-40°C ~ +105°C	Extraction force	> 50N
IP grade	IP67 when only receptacle	Environmental protection	Meet RoHS

## EBM emotor connector

### Product features

- ✓ Compact structure and high space utilization.
- ✓ The male connector protect the terminal providing with a protective cover.
- ✓ Operation simply in the way of straight mating.
- ✓ Beautiful appearance meet Ergonomic design.

### EBM straight angle plug



### EBM plug dimensional drawing

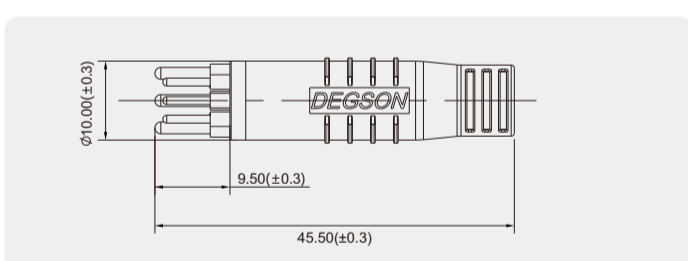

### Application Scope

EBIKE emotor interface connection

### EBM socket dimensional drawing

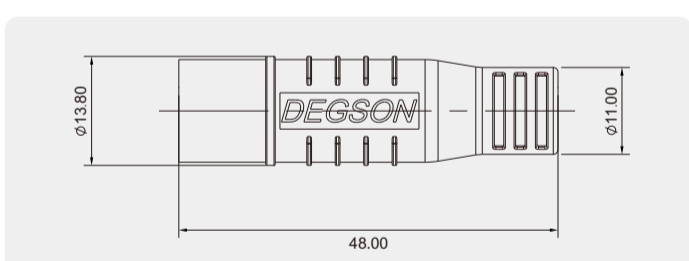

### Technical Data

Rated current	Power 50A, signal 2A	Wiring connection	Soldering
Rated voltage	60V DC	Salt spray resistance	Neutral salt spray 48h
Insulation resistance	≥30MΩ	Withstand voltage	500V AC
Flame retardant rating	UL94V-0	Mechanical life	≥100 times
Operating temperature	-25°C ~ +80°C	Extraction force	> 60N
IP grade	IP67 when mated	Environmental protection	Meet RoHS

## EBS Signal connector(2~6pins)

### Product features

- ✓ Compact structure and high space utilization.
- ✓ Automatic alignment when mating and Simple interface.
- ✓ Operation simply in the way of straight mating.
- ✓ Different colour contribute to recognise.
- ✓ Beautiful appearance meet Ergonomic design.

### EBS plug/socket



### EBS plug/socket dimensional drawing

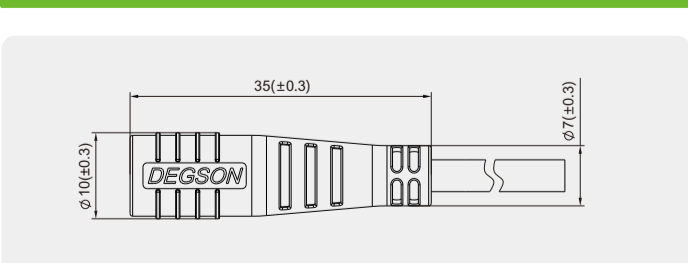

### Application Scope

This product can be applied to horn, light and brake handle of EBIKE.

### EBS socket dimensional drawing

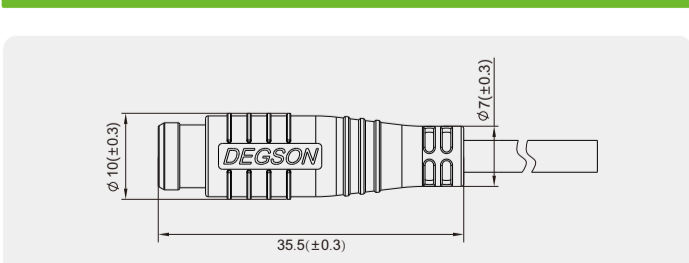

### Technical Data

Rated current	Power 50A, signal 2A	Wiring connection	Soldering
Rated voltage	48V DC	Salt spray resistance	Neutral salt spray 48h
Insulation resistance	≥30MΩ	Withstand voltage	300V AC
Flame retardant rating	UL94V-0	Mechanical life	≥100 times
Operating temperature	-25°C ~ +80°C	Extraction force	> 25N
IP grade	IP66 when mated	Environmental protection	Meet RoHS