

Shenler

Bring reliability to everything we RELAY

Electromagnetic Relay Product Catalogue

Industrial Relays | Interface Relays | Timers | Sockets and Accessories

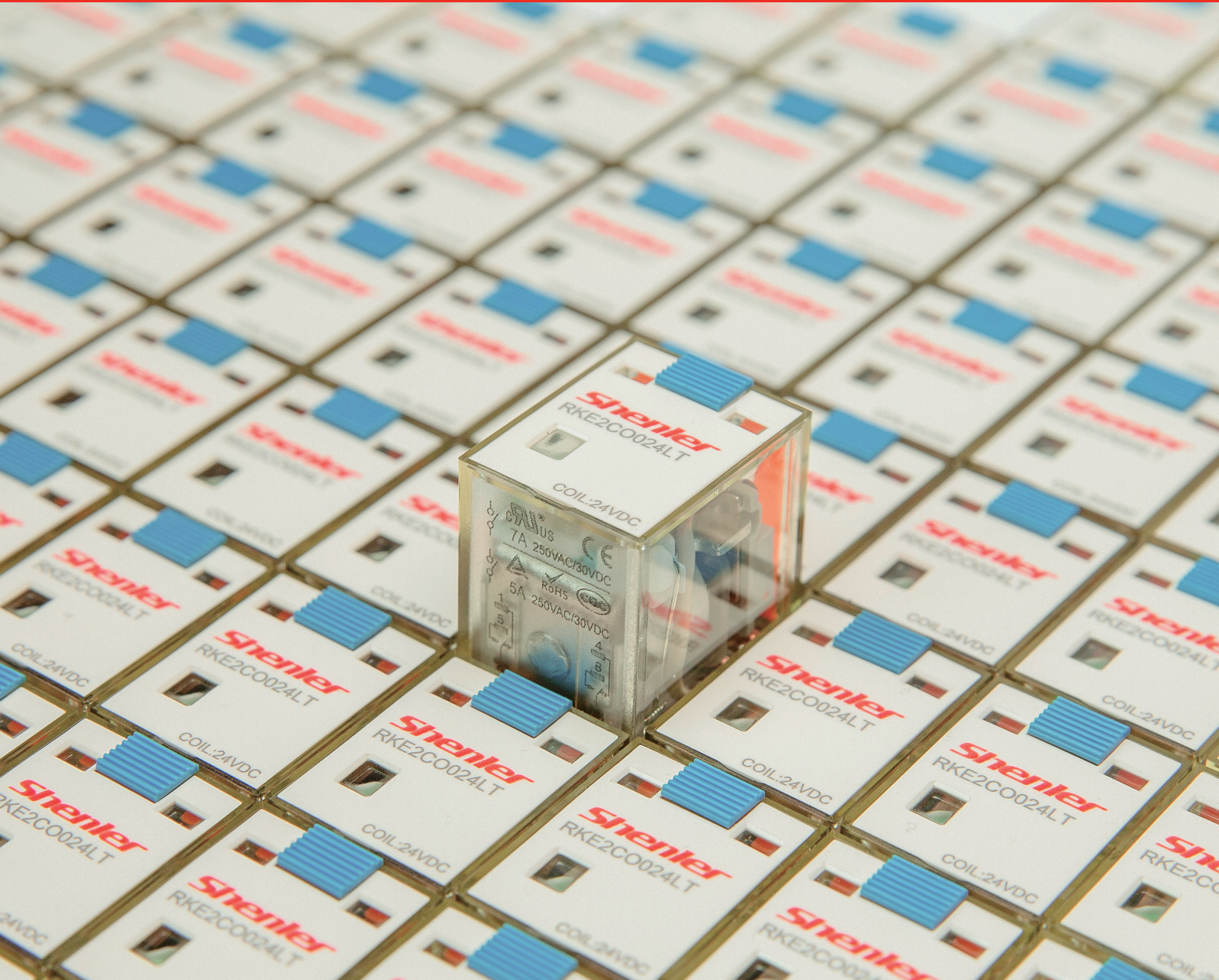

>>> About Shenler

Shenler Corporation Ltd., is a non regional joint-stock private enterprise dedicated to the R & D, manufacturing and sales of industrial relay products.

The development of the company can be traced back to the Yueqing Shenle relay factory established in 1985. In 1997, the company was successfully restructured and upgraded to Zhejiang Shenle Electric Co., Ltd. and in 2014, the company registered and established Shenle Co., Ltd. through restructuring. After more than 30 years of development, the company has passed the ISO9001 quality management system certification, and won the "top ten relay enterprises in China, national Spark Program project, outstanding award for independent innovation of scientific and technological achievements, National Torch Program industrialization demonstration project, top ten relay brands in China, AAA credit rating of high-tech enterprises in China, small and medium-sized technology-based enterprises in Zhejiang Province, and high-tech enterprises Industry, China International New Technology and new products Fair Gold Award, Wenzhou famous brand products "and other honors.

Shenle products have more than 80 series and more than 2600 relay and socket models. The products mainly include PCB Relay, industrial relay, interface relay, time relay, socket, accessories and module. The products have passed UL, CSA, CE, TUV, CQC and other certification.

Shenle's sales and service network covers the world. More than 65% of its products are exported to overseas countries. Its products are widely used in machinery manufacturing, hoisting machinery, machine tools, paper-making equipment, motor control, elevators, robots, food and beverage, rubber equipment, ceramic machinery, printing and packaging, injection molding machinery, textile machinery, logistics equipment, electronic manufacturing, petrochemical, new energy and other fields.

>>> Corporate Culture

Mission

Vitalize national brand with excellent quality

Vision

Let Shenle brand go to the world and become the industry leader

Values

Honest, trustworthy and Dedicated











Enterprise Spirit

Unity, Efficient, Innovation, Excellence

Shenler

>>> Contents

02 Industrial Relay Series

-  **02** RNC Interface Relay
-  **07** RFT Interface Relay
-  **14** RKM Miniature General Purpose Relay
-  **19** RKE Miniature General Purpose Relay
-  **23** RKE-LS Sealed Power Relay
-  **30** RKF Miniature General Purpose Relay
-  **34** RKF Magnetic Blow-out Power Relay
-  **40** RKL Miniature Power Relay
-  **45** REH Power Relay
-  **48** REH Magnetic Blow-out Power Relay
-  **51** RUB General Purpose Relay
-  **55** RGF Power Relay
-  **57** R2G Power Relay



63 Timer Series

-  **63** TKB Timer Relay
-  **65** TCN Digital Timer
-  **67** TCR Solid-state Timer
-  **69** TMC7-□Solid-State Counter





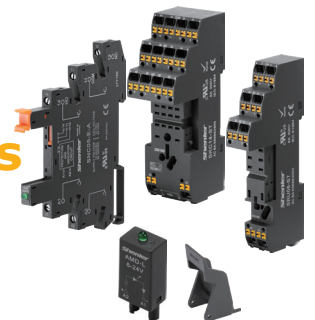

71 Socket and Accessory Series

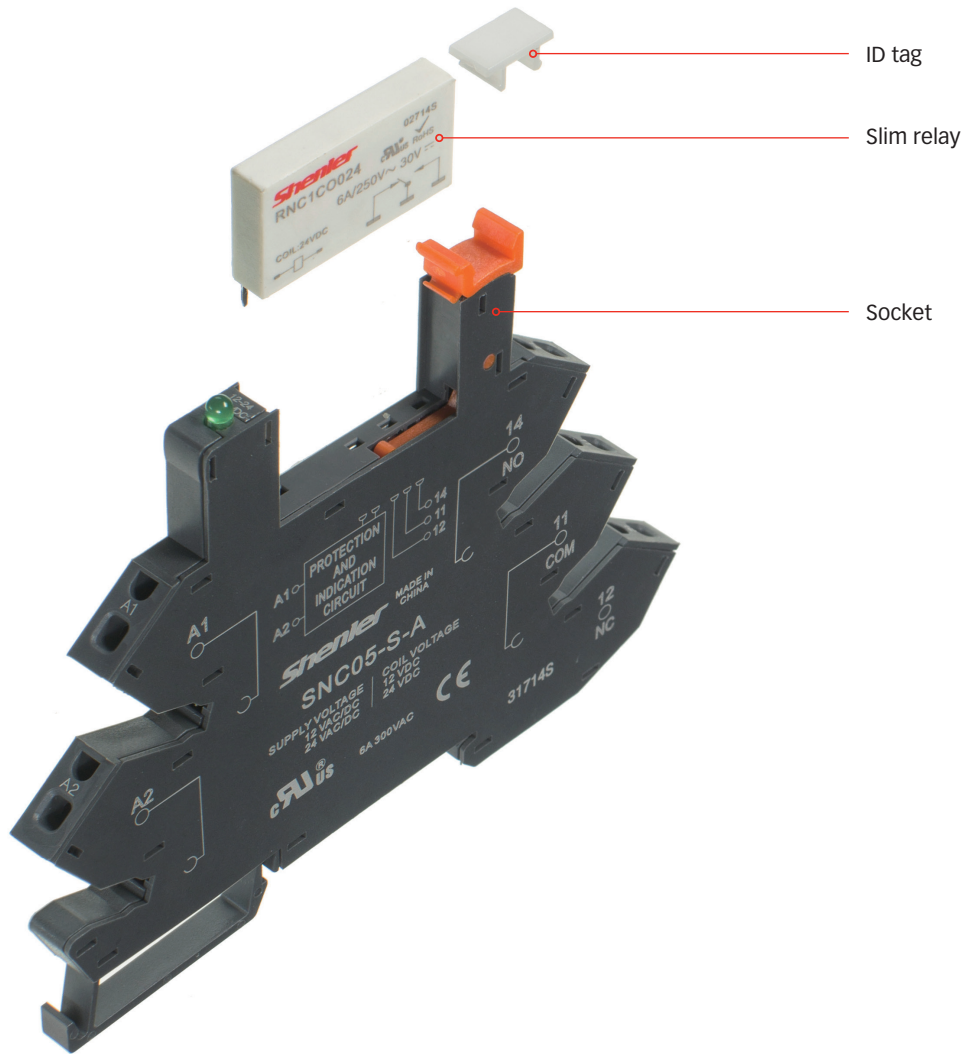

>>> RNC Interface Relay



>>> Other applicable sockets and accessories selection table

			
SNC05-E	SNC05-P	SN20B	SN20S

Note: Applicable protection modules and accessories please refer to Page 71 to 73.



RNC1CO/1CP



Features

- > 5mm thickness, up to 6A breaking capacity.
- > Conformity with RoHS directive.
- > Wide choice of sockets available covering a range of voltages from 3 to 230V.

Ordering Information

RNC

Contact form _____
 1A: (NO)
 1C: (CO)

Terminal arrangement _____
 O: Vertical pin
 P: Horizontal pin

Coil voltage code _____

Code	003	005	006	012	018	024
Voltage (V DC)	3	5	6	12	18	24
Code	048	060				
Voltage (V DC)	48	60				

Other options _____
 Blank: Conventional
 V: Coil consumption 0.21W (only to 3~24VDC)
 G: Gold plated contact

Characteristics

	Configuration	1A, 1C
	Load Resistance	6A/250VAC 30VDC
	Switching capacity (resistive)	1500VA 180W
Contact	Initial contact resistance	≤100mΩ (gold plated contact ≤ 30mΩ)
	Material	Ag alloy
	Electrical durability	NO: 6x10 ⁴ ; NC: 3x10 ⁴ times (1800 Ops/h)
	Mechanical durability	≥2 x 10 ⁷ times (18000 Ops/h)
	Pick-up voltage (23°C)	DC: ≤75% (Rated voltage)
Drop-out voltage (23°C)	DC: ≥5% (Rated voltage)	
Maximum voltage (23°C)	110% (Rated voltage)	
Insulation resistance	≥1000MΩ (500VDC)	
Coil operating power	3~24 VDC	approx. 0.17 W
	48~60 VDC	approx. 0.21 W
Operate time (at nominal voltage)	≤8ms	
Release time (at nominal voltage)	≤4ms	
Initial breakdown voltage	Between open contacts	1000VAC/1min (leakage current 1mA)
	Between contacts and coil	4000VAC/1min (leakage current 1mA)
Ambient temperature	-40~+85°C	
Humidity	5%~85%RH	
Air pressure	86~106KPa	
Shock resistance	10G (half-sine shock pulse: 11ms)	
Vibration resistance	10~55Hz double-amplitude:1.0mm	
Mounting	PCB	
Unit weight	6g	

>>> RNC Interface Relay

Coil Specifications (23°C)

Nominal voltage V.DC (0.17W)	3	5	6	12	18	24
Coil resistance Ω	43	147	212	847	1906	3388
Nominal voltage V.DC (0.21W)	48	60				
Coil resistance Ω	10971	17143				

Remark: Coil resistance under coil voltage 48V are measured with tolerance of $\pm 10\%$, above coil voltage 48V are measured with tolerance of $\pm 15\%$.

Contact Specification

RNC1A, 1C

Electrical durability contacts

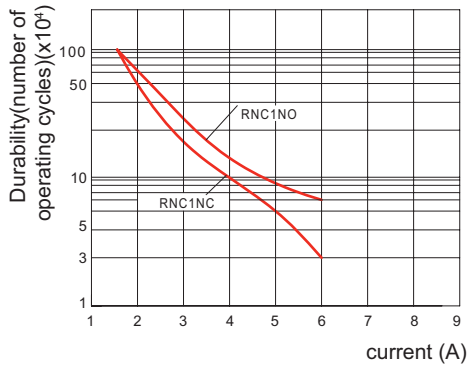

Maximum switching capacity

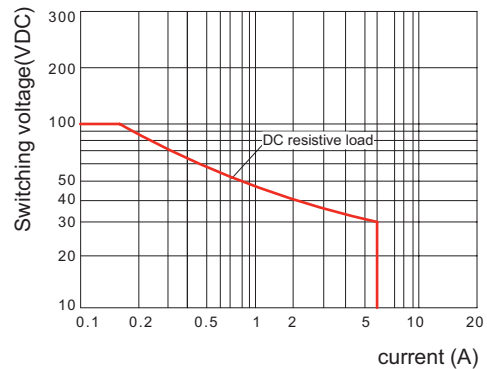

Dimensions (mm)

1CO

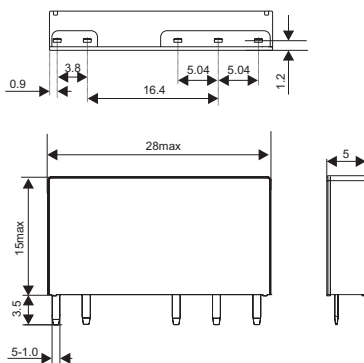

1AO

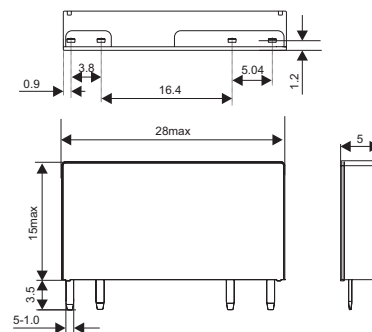

1CP

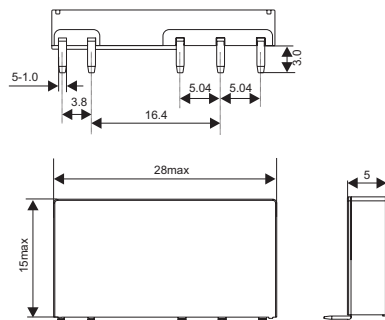

1AP

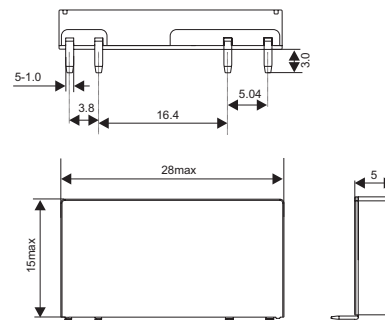

Wiring Diagrams

1CO Bottom view



1AO Bottom view



1CP

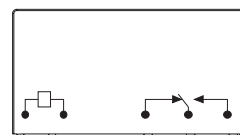

1AP

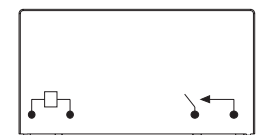

RNC Socket

▶▶ **SNC05-E**

Presentation

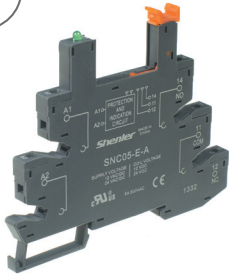

8 AMPS 300 VOLTS



Model No.	Input	For use with relay coil voltage
SNC05-E-A	12/24V	12/24VDC
SNC05-E-B	48/60V	48/60VDC
SNC05-E-C	110V	60VDC
SNC05-E-D	230V	60VDC

Characteristics

Nominal load	Current	A	8
	Voltage	V	300
Dielectric strength	Between coil and contact	V/min	4000
	Between contacts	V/min	2500
Max. tightening torque	Nm		0.5
Wire size	AWG/mm ²		20-16/0.5-1.5
Ambient temperature	°C		-40~+85
Unit weight	g		24

Relay,accessories selection table

Socket	Bus jumper	Legend	Partition plate	DIN rail
SNC05-E	SN20B	SN64P	SN20S	PFP

Dimensions (mm)

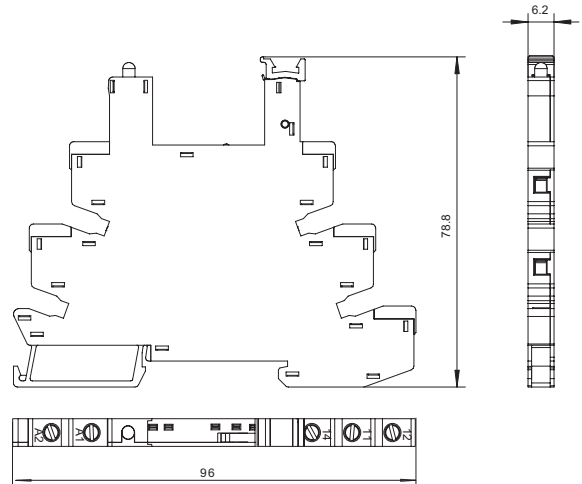

Connection Diagrams

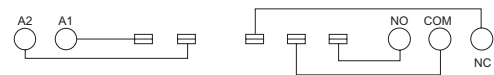

▶▶ **SNC05-S**

Presentation

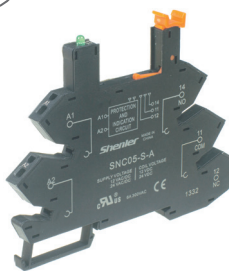

8 AMPS 300 VOLTS



Model No.	Input	For use with relay coil voltage
SNC05-S-A	12/24V	12/24VDC
SNC05-S-B	48/60V	48/60VDC
SNC05-S-C	110V	60VDC
SNC05-S-D	230V	60VDC

Characteristics

Nominal load	Current	A	8
	Voltage	V	300
Dielectric strength	Between coil and contact	V/min	4000
	Between contacts	V/min	2500
Max. tightening torque	Nm		-
Wire size	AWG/mm ²		20-16/0.5-1.5
Ambient temperature	°C		-40~+85
Unit weight	g		25

Relay,accessories selection table

Socket	Bus jumper	Legend	Partition plate	DIN rail
SNC05-S	SN20B	SN64P	SN20S	PFP

Dimensions (mm)

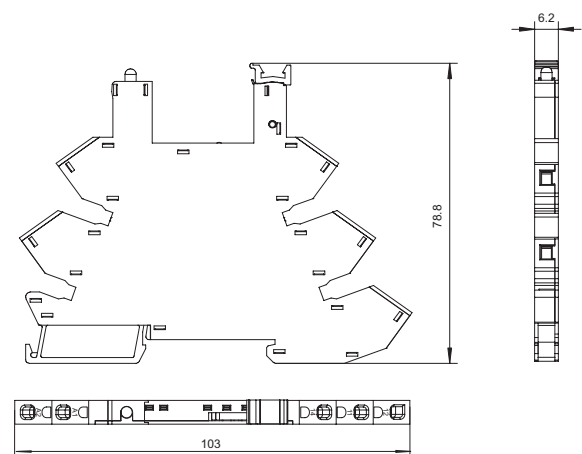

Connection Diagrams

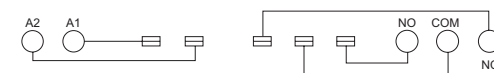

>>> RNC Interface Relay

RNC Socket

>>> SNC05-P

Presentation



8 AMPS 300 VOLTS



Dimensions (mm)

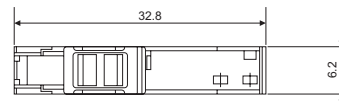
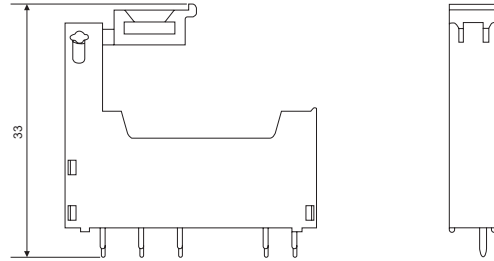

Characteristics

Nominal load	Current	A	8
	Voltage	V	300
Dielectric strength	Between coil and contact	V/S	4000
	Between contacts	V/S	2500
Ambient temperature		°C	-40~+85
Unit weight		g	25

Relay, accessories selection table

Socket	Bus jumper	Legend	Partition plate	DIN rail
SNC05-P	-	-	-	-

Connection Diagrams

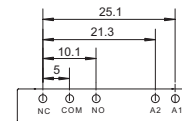

>>> RFT Interface Relay

Shenler
>>> Industrial Relay Series

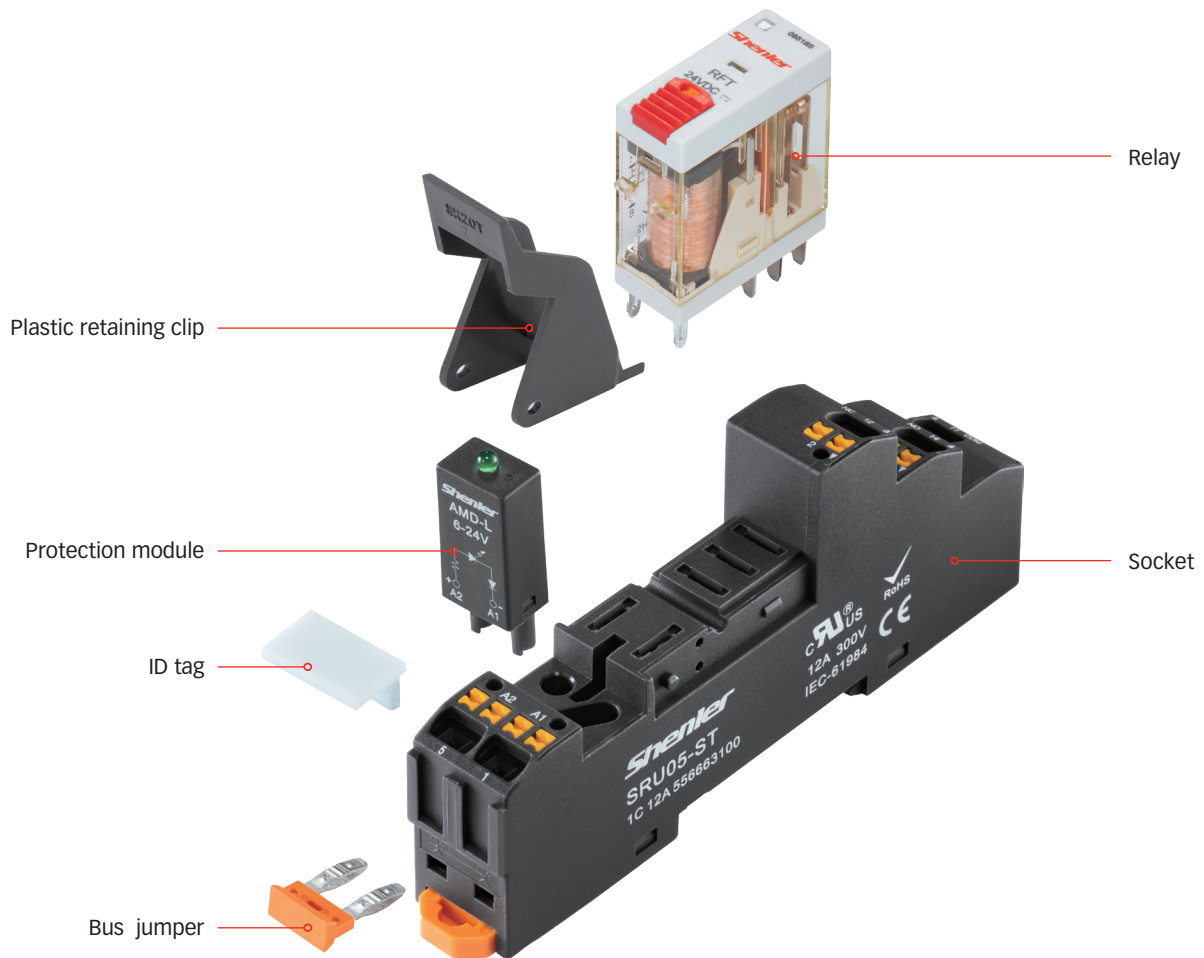

>>> Other applicable sockets and accessories selection table

SRT00-E	SRT00-A	SRT00-ES	SRU00-E	SRU00-S	SRU00-ST	SRT00-P	SR08C	ST01CC

Note: Applicable protection modules and accessories please refer to Page 71 to 73.

>>> RFT Interface Relay

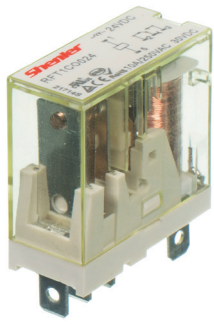

RFT1CO

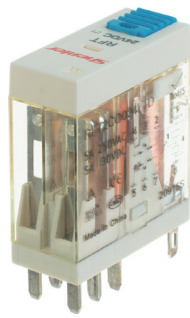

RFT2CO-LT

Features

- > Slim and compact size
- > 1 pole 12A; 2 pole 8A
- > With non-polarity LED integrated in relay
- > With lockable test button and inspection window
- > Identification of coils through test button color (AC red/DC blue)
- > Conformity with RoHS Directive

Ordering Information

RFT

Contact form _____

1C: 1CO

2C: 2CO

Terminal arrangement _____

O: plug in

Coil voltage code _____

Code	006	012	024	036	048	110	
Voltage (V DC)	6	12	24	36	48	110	
Code	506	512	524	548	615	730	740
Voltage (V AC)	6	12	24	48	115	230	240

Options _____

blank: standard type

L: with LED

D: with diode (1-,5+ ; 1-,8+)

D1: with diode(1+,5-; 1+,8-)

LD: with LED and diode (1-,5+ ; 1-,8+)

LD1: with LED and diode (1+,5-; 1+,8-)

LT: LED + Test button

LTD: LED + test button+diode (1-, 5+; 1-, 8+)

LTD1: LED + test button+diode (1+, 5-; 1+, 8-)

B: cover with flange (selection plus B,namely LB,DB,LDB, etc.)



Characteristics

		1C	2C
Contact	Configuration	1C	2C
	Rated current/ Resistive load	12A/250VAC, 30VDC	8A/250VAC, 30VDC
	Rated voltage Motor load	1/3HP, 240VAC	1/6HP, 240VAC
	Switching capacity (resistive)	3000VA, 360W	2000VA, 240W
	Initial contact resistance	≤50mΩ	
	Material	Ag alloy	
	Electric durability (110% rated voltage , 55°C)	≥20 x 10 ⁴ (1800 Ops/h)	
	Electric durability (Normal temperature)	≥30 x 10 ⁴ (600 Ops/h)	
	Mechanical durability	≥2000 x 10 ⁴ (18000 Ops/h)	
	Pick-up voltage (23°C)	DC:≤75% (rated voltage), AC:≤80% 50/60Hz (rated voltage)	
Drop-out voltage (23°C)	DC:≥10% (rated voltage),AC:≥30% 50/60Hz (rated voltage)		
Maximum voltage (23°C)	110% (rated voltage)		
Insulation resistance	≥1000MΩ (500VDC)		
Coil operating power	DC (W)	approx. 0.53	
	AC (VA)	approx. 1.0	
Operate time (at nominal voltage)	≤20ms		
Release time (at nominal voltage)	≤10ms		
Initial breakdown voltage	Between open contacts	1000VAC/1min (leakage current 1mA)	
	Between poles	3000VAC/1min (leakage current 1mA)	
	Between contacts and coil	5000VAC/1min (leakage current 1mA)	
Ambient temperature	-40~+55°C		
Humidity	5%~85%RH		
Air pressure	86~106KPa		
Shock resistance	10G (half-sine shock pulse: 11ms)		
Vibration resistance	10~55Hz double-amplitude: 1.0mm		
Mounting	plug in		
Unit weight	Approx. 18g		

Coil Specifications (23°C)

Nominal voltage V.DC	6	12	24	36	48	110	
Coil resistance Ω	68	270	1100	2440	4300	22800	
Nominal voltage V.AC	6	12	24	48	115	230	240
Coil resistance Ω	16	63	240	1085	6300	23000	25000

Remark: Coil resistance under coil voltage 110V are measured with tolerance of ±10%Ω, above coil voltage 110V are measured with tolerance of ±15%Ω.

Contact Specification

RFT1CO

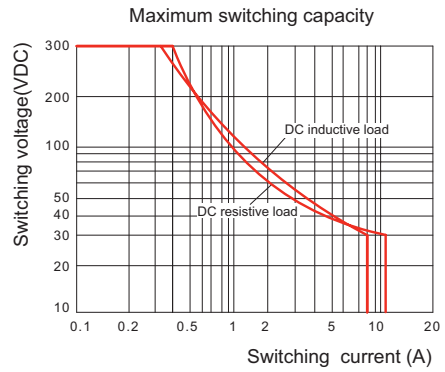
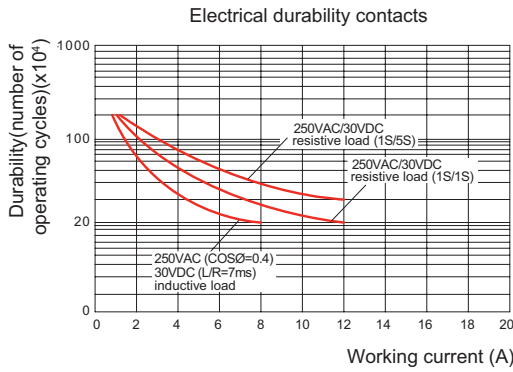

RFT2CO

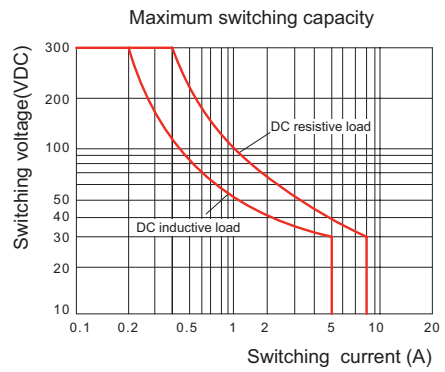
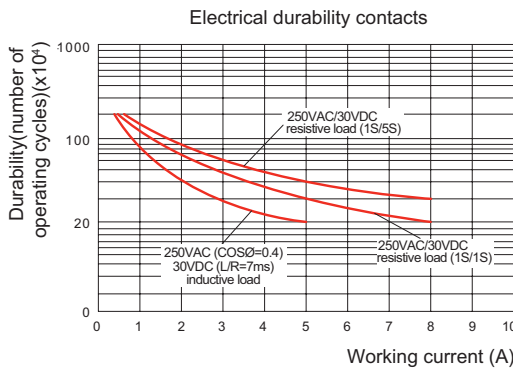

Dimensions (mm)

RFT1C

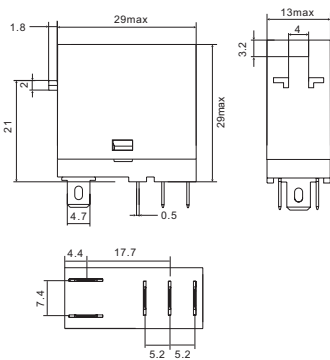

RFT2C

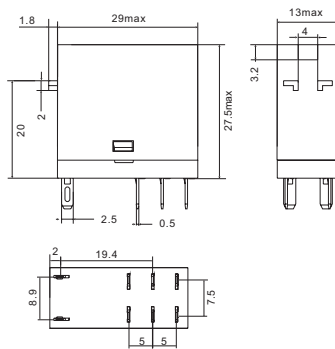

RFT1CO-LT

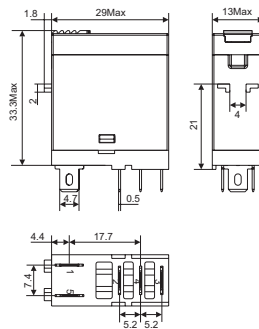

RFT2CO-LT

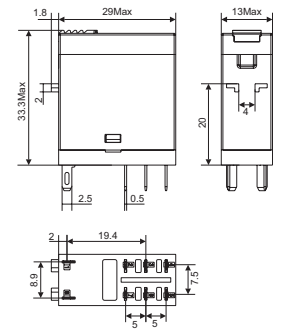

RFT1CO-B

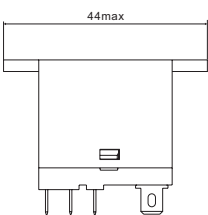

RFT2CO-B

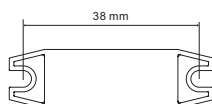
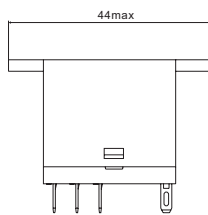

Wiring Diagrams

RFT1CO

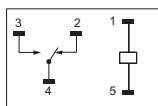

RFT1COL/LT AC

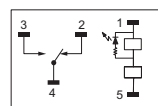

RFT1COL/LT DC

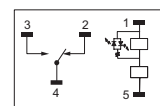

RFT1COLD/LTD DC

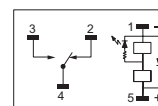

RFT1COLD1/LTD1

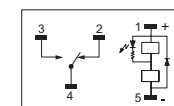

RFT2CO

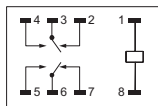

RFT2COL/LT AC

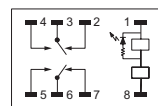

RFT2COL/LT DC

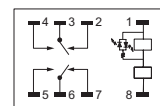

RFT2COLD/LTD DC

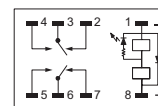

RFT2COLD1/LTD1

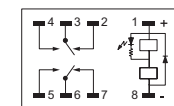

>>> RFT Interface Relay

RFT Socket

>>> SRT□□-E

Presentation

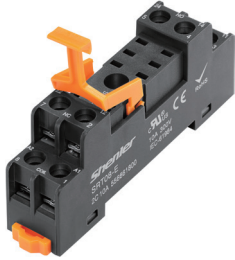

10/16 AMPS 300 VOLTS



Characteristics

Type			SRT05-E	SRT08-E
Nominal load	Current	A	16	10
	Voltage	V	300	
Dielectric strength	Between coil and contact	V/min	4000	
	Between contacts	V/min	2500	
Max. tightening torque		Nm	1.0	
Wire size		AWG/mm ²	20-14/0.5-2.5	
Ambient temperature		°C	-45~85	
Unit weight		g	22	27

Relay, accessories selection table

Socket	Plastic clip	Metal clip	ID tag	Module	DIN rail	Bus jumper
SRT05-E	SR20	-	-	-	PPF	SR08C
SRT08-E	(included in socket)	-	-	-	PPF	SR08C

Dimensions (mm)

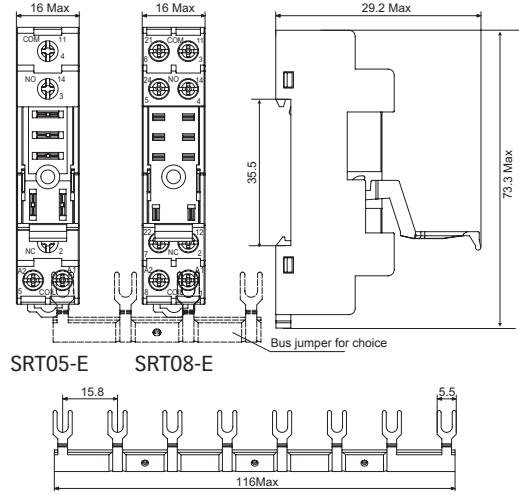

Connection Diagrams

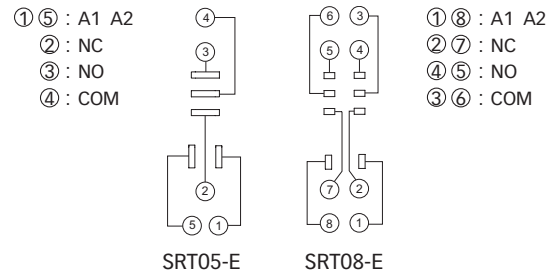

>>> SRT□□-A

Presentation

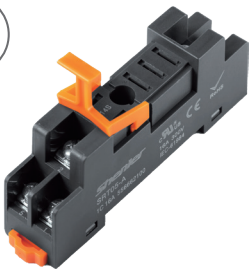

10/16 AMPS 300 VOLTS



Characteristics

Type			SRT05-A	SRT08-A
Nominal load	Current	A	16	10
	Voltage	V	300	
Dielectric strength	Between coil and contact	V/min	4000	
	Between contacts	V/min	2500	
Max. tightening torque		Nm	1.0	
Wire size		AWG/mm ²	20-14/0.5-2.5	
Ambient temperature		°C	-45~85	
Unit weight		g	22	27

Relay, accessories selection table

Socket	Plastic clip	Metal clip	ID tag	Module	DIN rail	Bus jumper
SRT05-A	SR20	-	-	-	PPF	SR08C
SRT08-A	(included in socket)	-	-	-	PPF	SR08C

Dimensions (mm)

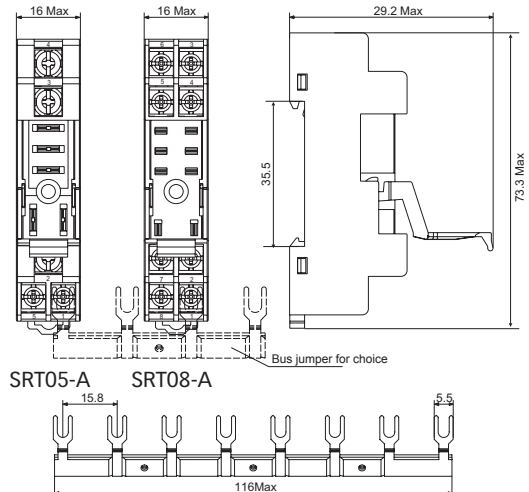

Connection Diagrams

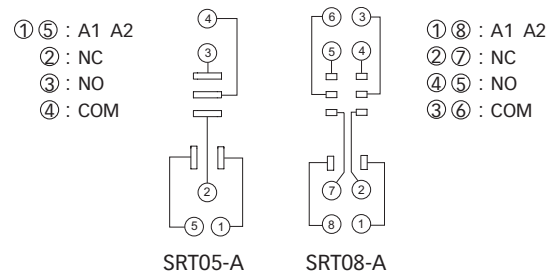

RFT Socket

>>> SRU□□-E

Presentation



10/16 AMPS 300 VOLTS



Characteristics

Type			SRU05-E	SRU08-E
Nominal load	Current	A	16	10
	Voltage	V	300	
Dielectric strength	Between coil and contact	V/min	4000	
	Between contacts	V/min	2500	
Max. tightening torque		Nm	1.0	
Wire size		AWG/mm ²	20-14/0.5-2.5	
Ambient temperature		°C	-45~+85	
Unit weight		g	35	43

Relay, accessories selection table

Socket	Plastic clip	Metal clip	ID tag	Module	DIN rail	Bus jumper
SRU05-E	SR20T	-	SR2P	AMD	PFP	SR08B
SRU08-E						

>>> SRT□□-P

Presentation



10/16 AMPS 300 VOLTS



Characteristics

Type			SRT05-P	SRT08-P
Nominal load	Current	A	16	10
	Voltage	V	300	
Dielectric strength	Between coil and contact	V/min	4000	
	Between contacts	V/min	2500	
Ambient temperature		°C	-40~+65	
Unit weight		g	4	

Dimensions (mm)

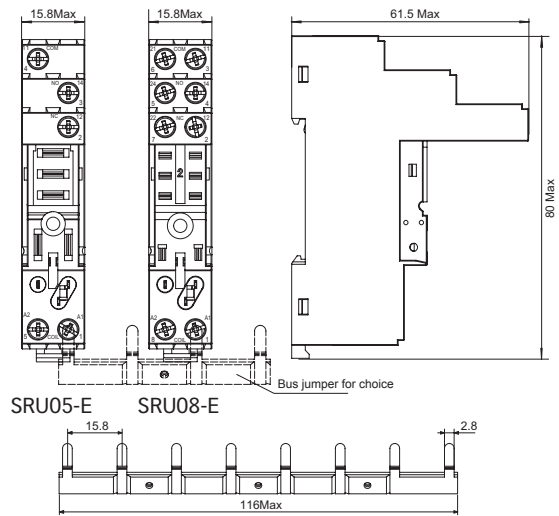

Connection Diagrams

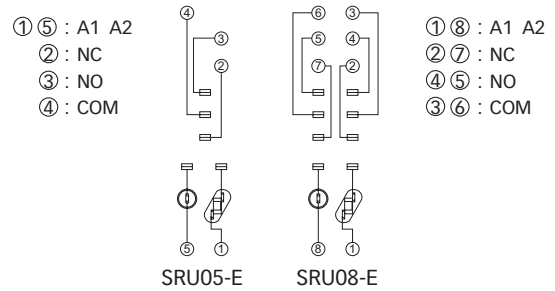

Dimensions (mm)

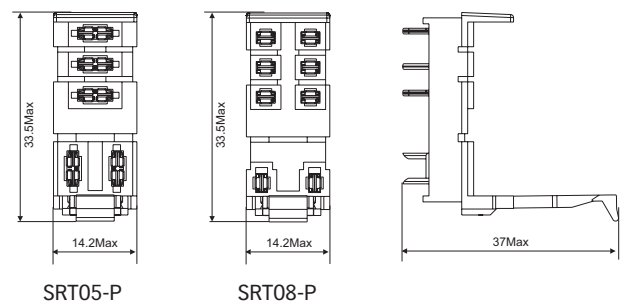

Connection Diagrams

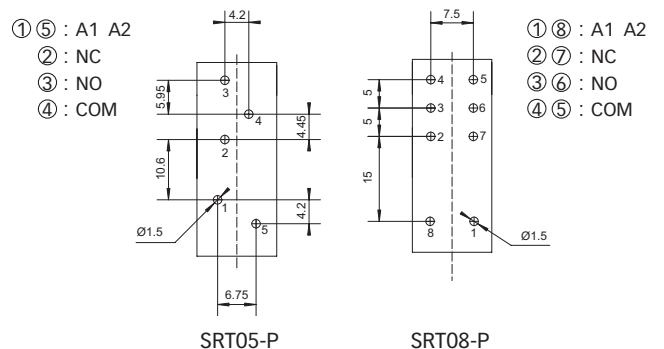

>>> RFT Interface Relay

RFT Socket

>>> SRU□□-S

Presentation



New

10/16 AMPS 300 VOLTS



Characteristics

Type			SRU05-S	SRU08-S
Nominal load	Current	A	16	10
	Voltage	V	300	
Dielectric strength	Between coil and contact	V/min	4000	
	Between contacts	V/min	2500	
Max. tightening torque		Nm	-	
Wire size		AWG/mm ²	20-14/0.5-2.5	
Ambient temperature		°C	-45~+85	
Unit weight		g	35	43

Relay, accessories selection table

Socket	Plastic clip	Metal clip	ID tag	Module	DIN rail	Bus jumper
SRU05-S	SR20T	-	SR2P	AMD	PFP	ST01CC
SRU08-S						

Dimensions (mm)

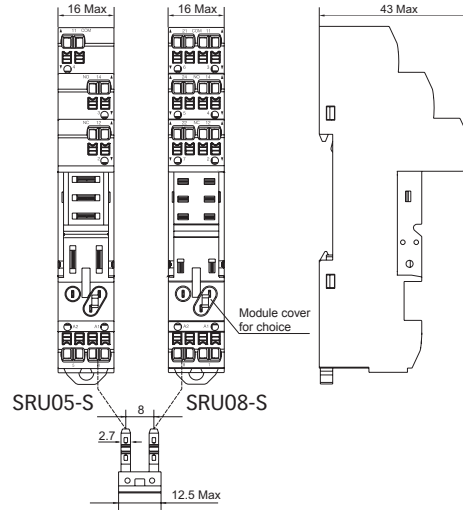

Connection Diagrams

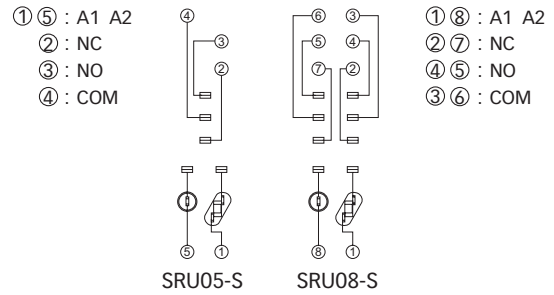

>>> SRU□□-ST

Presentation



New

10/16 AMPS 300 VOLTS



Characteristics

Type			SRU05-ST	SRU08-ST
Nominal load	Current	A	16	10
	Voltage	V	300	
Dielectric strength	Between coil and contact	V/min	4000	
	Between contacts	V/min	2500	
Max. tightening torque		Nm	-	
Wire size		AWG/mm ²	20-14/0.5-2.5	
Ambient temperature		°C	-45~+85	
Unit weight		g	35	43

Relay, accessories selection table

Socket	Plastic clip	Metal clip	ID tag	Module	DIN rail	Bus jumper
SRU05-ST	SR20T	-	SR2P	AMD	PFP	ST01CC
SRU08-ST						

Dimensions (mm)

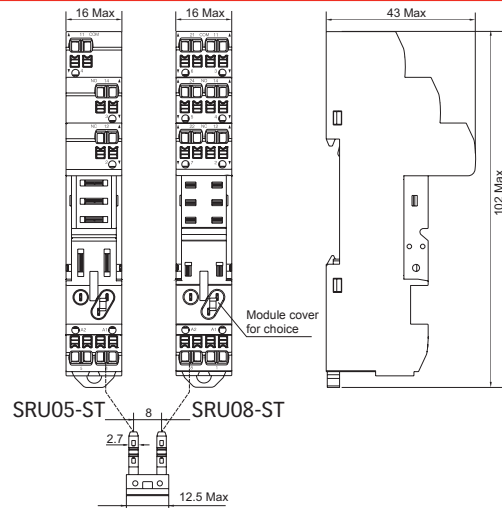

Connection Diagrams

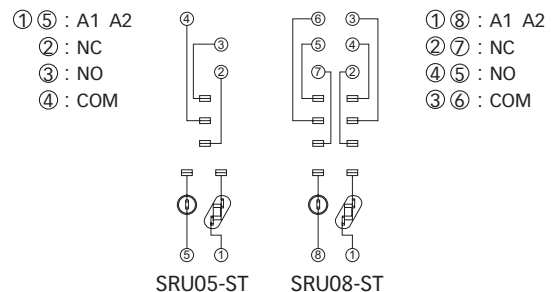

RFT Socket

>>> SRT□□-ES

Presentation



New

10/16 AMPS 300 VOLTS



Characteristics

Type			SRT05-ES	SRT08-ES
Nominal load	Current	A	16	10
	Voltage	V		300
Dielectric strength	Between coil and contact	V/min		4000
	Between contacts	V/min		2500
Max. tightening torque		Nm		1.0
Wire size		AWG/mm ²	20-14/0.5-2.5	
Ambient temperature		°C	-45~85	
Unit weight		g	22	27

Relay, accessories selection table

Socket	Plastic clip	Metal clip	ID tag	Module	DIN rail	Bus jumper
SRT05-ES	SR20L (included in socket)	-	-	-	PFP	SR08C
SRT08-ES						

Dimensions (mm)

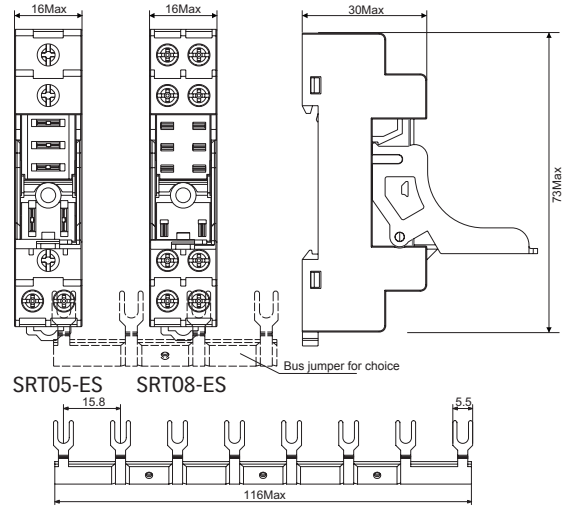

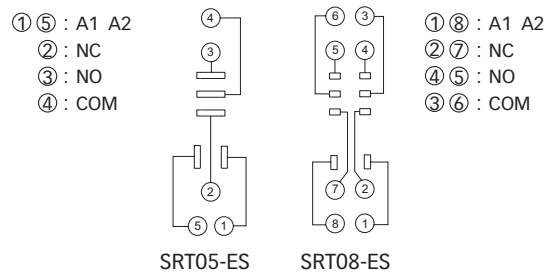

Connection Diagrams

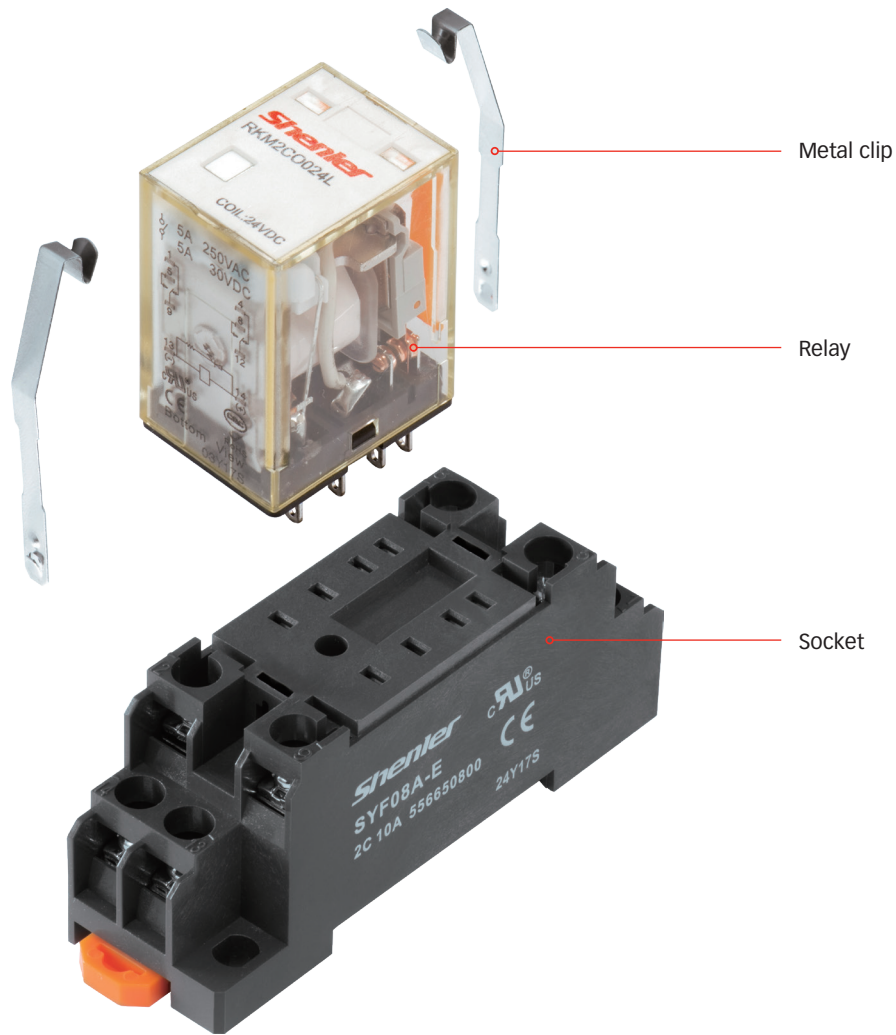

>>> RKM Miniature General Purpose Relay

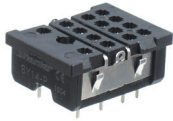

>>> Other applicable sockets selection table

		
SYF00E	SYF00A	SY00P

Note: Applicable protection modules and accessories please refer to Page 71 to 73.

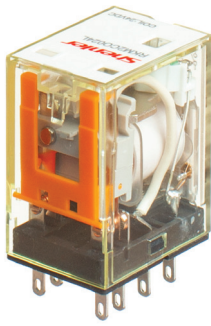

RKM2CO



RKM4CO



Features

- > 2 pole 5A, 4 pole 3A
- > With LED integrated in relay
- > With inspection window

Ordering Information

RKM

Contact form _____

2C: 2CO
4C: 4CO

Mount options _____

O: plug in

Coil voltage code _____

Code	006	012	024	036	048	110	220	
Voltage (V DC)	6	12	24	36	48	110	220	
Code	506	524	536	548	615	730	740	880
Voltage (V AC)	6	24	36	48	115	230	240	380

Options

- L: LED
- LD: LED + Test button (13-, 14+)
- LD1: LED + Test button (13+, 14-)

Characteristics

		2C	4C	
Contact	Configuration	2C	4C	
	Rated current/ Rated voltage	Resistive load	5A/250VAC, 30VDC	3A/250VAC, 30VDC
		Motor load	1/3HP, 240VAC	1/6HP, 240VAC
	Switching capacity (resistive)	1250VA, 150W	750VA, 90W	
	Initial contact resistance	≤50mΩ		
	Material	Ag alloy		
	Electric durability (110%rated voltage, 55°C)	≥20 x 10 ⁴ (1800 Ops/h)		
	Electric durability (Normal temperature)	≥40 x 10 ⁴ (360 Ops/h)		
Mechanical durability	≥2000 x 10 ⁴ (1800 Ops/h)			
Pick-up voltage (23°C)	DC: ≤75% (Rated voltage), AC: ≤80% 50/60Hz (Rated voltage)			
Drop-out voltage (23°C)	DC: ≥10% (Rated voltage), AC: ≥30% 50/60Hz (Rated voltage)			
Maximum voltage (23°C)	110% (Rated voltage)			
Insulation resistance	≥1000MΩ (500VDC)			
Coil operating power	DC (W)	approx. 0.9		
	AC (VA)	approx. 1.2		
Operate time (at nominal voltage)	≤20ms			
Release time (at nominal voltage)	≤20ms			
Initial breakdown voltage	Between open contacts	1000VAC/1min (leakage current 1mA)		
	Between poles	2000VAC/1min (leakage current 1mA)		
	Between contacts and coil	2000VAC/1min (leakage current 1mA)		
Ambient temperature	-55~+70°C			
Humidity	35%~85%RH			
Air pressure	86~106KPa			
Shock resistance	10G (half-sine shock pulse: 11ms)			
Vibration resistance	10~55Hz double-amplitude:1.0mm			
Mounting	plug in			
Unit weight	35g			

>>> RKM Miniature General Purpose Relay

Coil Specifications (23°C)

Nominal voltage V.DC	6	12	24	36	48	110	220	
Coil resistance Ω	40	180	640	1500	2600	13000	42000	
Nominal voltage V.AC	6	24	36	48	115	230	240	380
Coil resistance Ω	11.5	180	370	640	4430	16500	18790	42000

Remark: Coil resistance under coil voltage 110V are measured with tolerance of $\pm 10\%\Omega$, above coil voltage 110V are measured with tolerance of $1 \pm 15\%\Omega$.

Contact Specification

RKM2CO

Electrical durability contacts

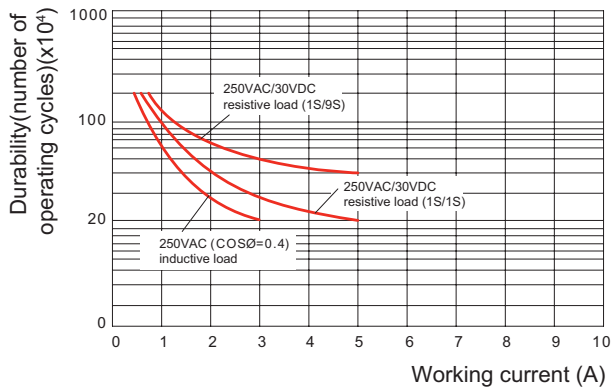

Maximum switching capacity

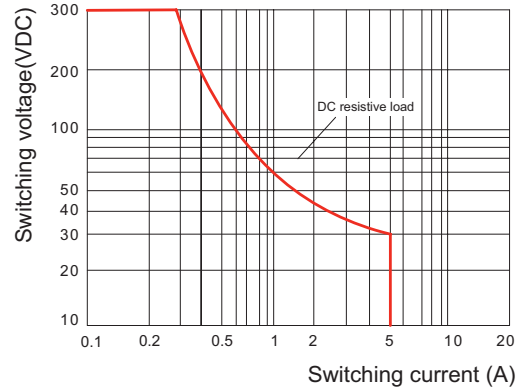

RKM4CO

Electrical durability contacts

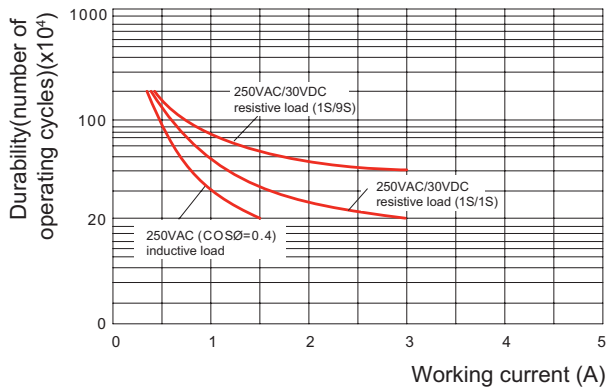

Maximum switching capacity

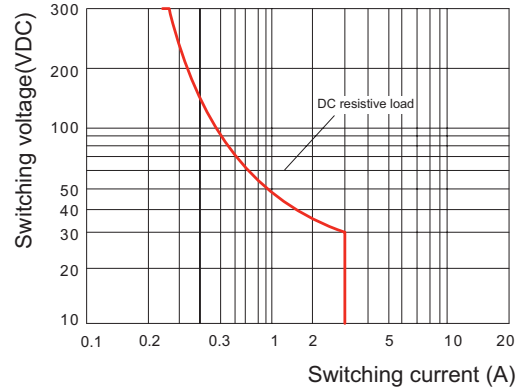

Dimensions (mm)

RKM2CO

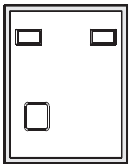
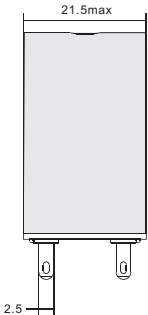
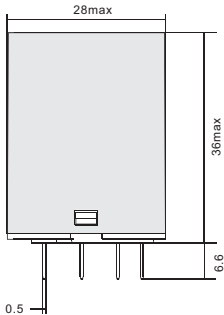

RKM4CO

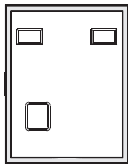
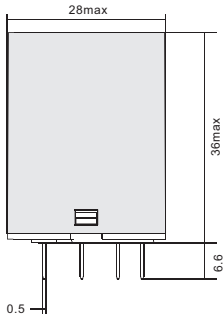

Wiring Diagrams

RKM2CO

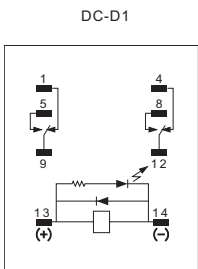
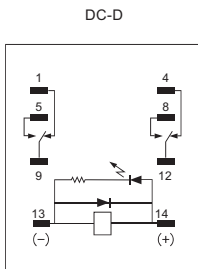
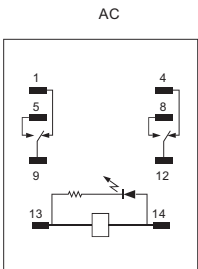
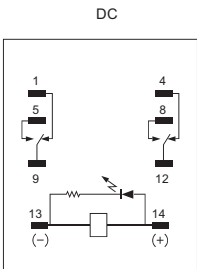
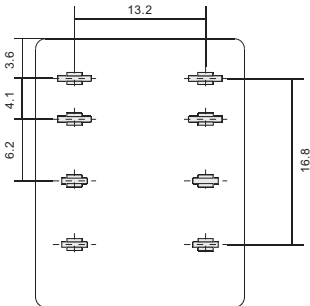

RKM4CO

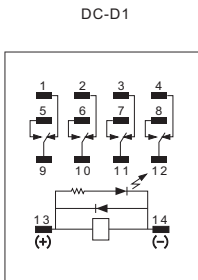
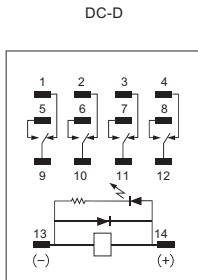
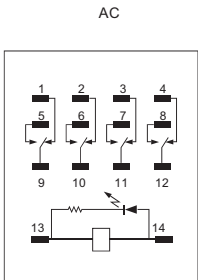
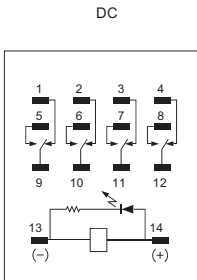
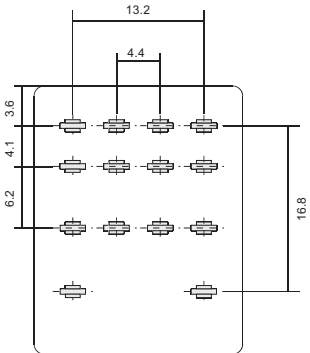

>>> RKM Miniature General Purpose Relay

RKM Socket

>>> SYF□□A-E

Presentation



7/10 AMPS 300 VOLTS



Characteristics

Type			SYF08A-E	SYF11A-E	SYF14A-E
Nominal load	Current	A	10	7	7
	Voltage	V	300		
Dielectric strength	V/min	2000			
Max. tightening torque	Nm	1.0			
Wire size	AWG/mm ²	20-14/0.5-2.5			
Ambient temperature	°C	-40~+65			
Unit weight	g	37	56	57	

Relay, accessories selection table

Socket	Plastic clip	Metal clip	ID tag	Module	DIN rail
SYF08A-E	-	SY36S	-	-	PFP
SYF11A-E					
SYF14A-E					

Dimensions (mm)

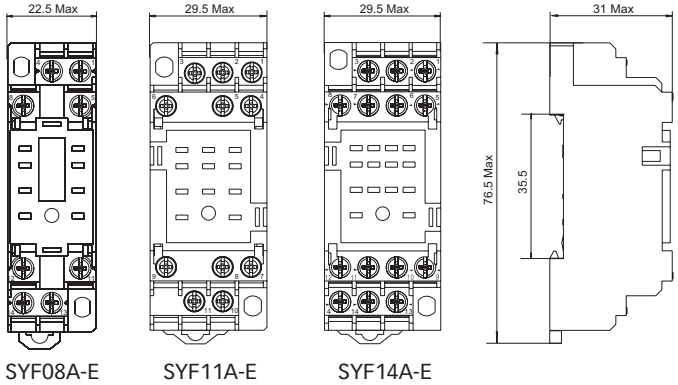

Connection Diagrams

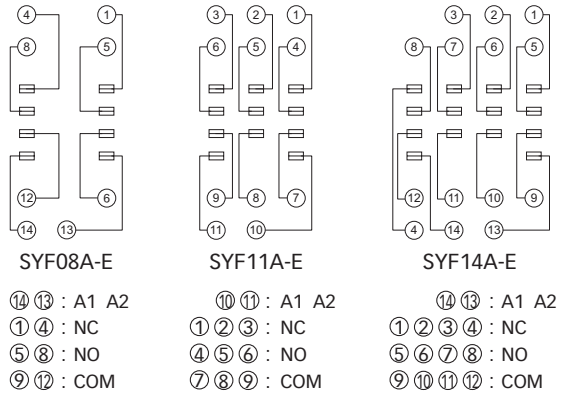

>>> SYF□□A

Presentation



7/10 AMPS 300 VOLTS



Characteristics

Type			SYF08A	SYF11A	SYF14A
Nominal load	Current	A	10	7	7
	Voltage	V	300		
Dielectric strength	V/min	2000			
Max. tightening torque	Nm	1.0			
Wire size	AWG/mm ²	20-14/0.5-2.5			
Ambient temperature	°C	-40~+65			
Unit weight	g	34	47	56	

Relay, accessories selection table

Socket	Plastic clip	Metal clip	ID tag	Module	DIN rail
SYF08A	-	SY36S	-	-	PFP
SYF11A					
SYF14A					

Dimensions (mm)

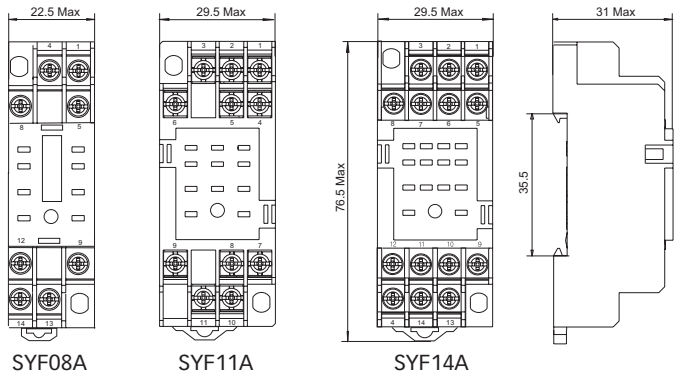



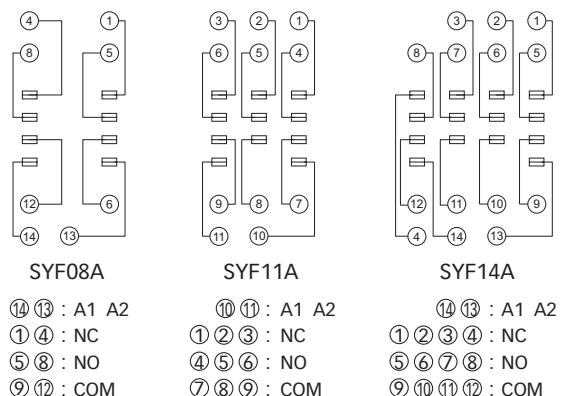

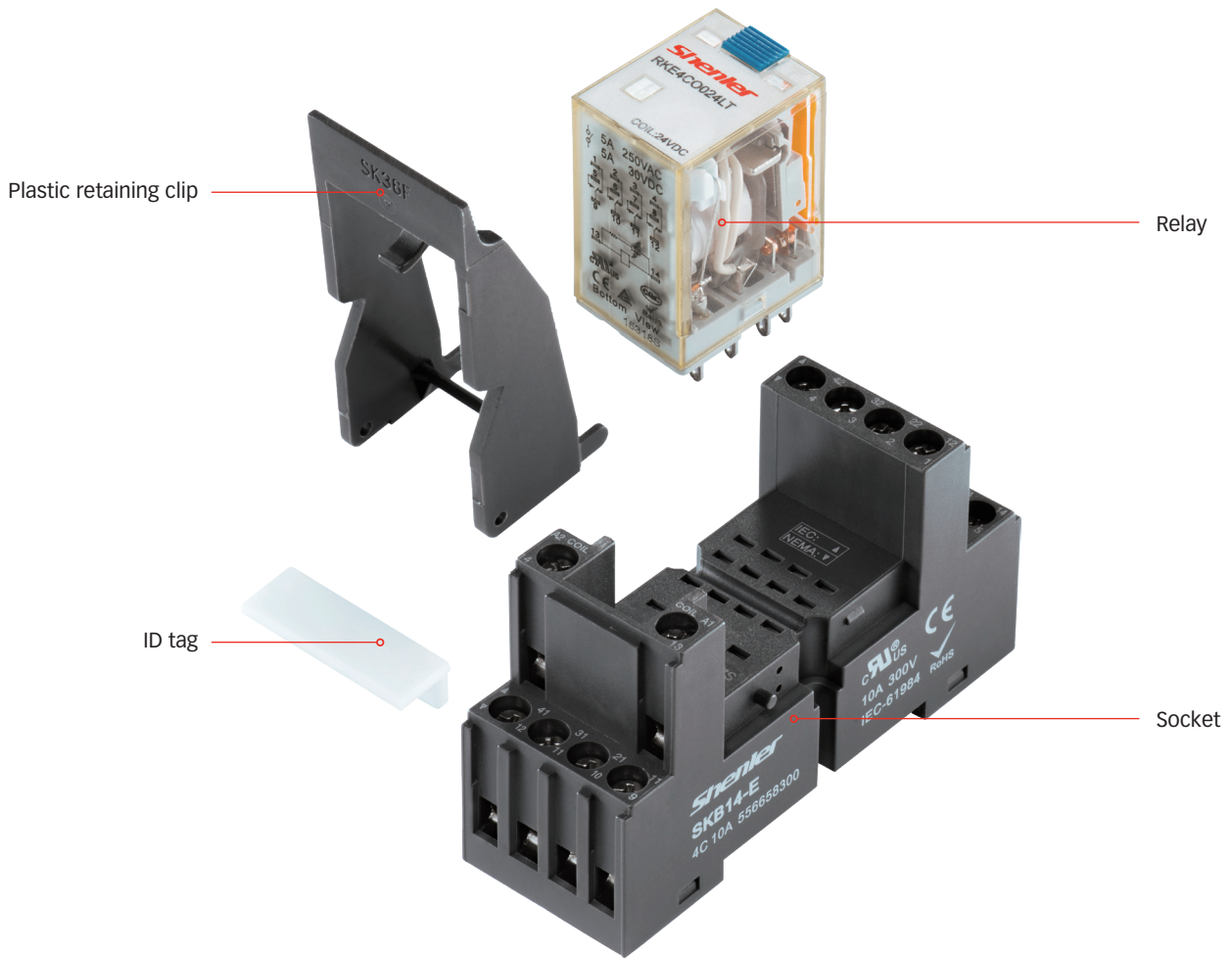

Connection Diagrams



>>> RKE Miniature General Purpose Relay

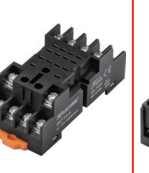
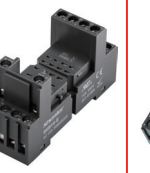
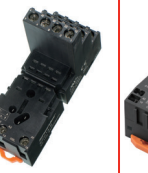

>>> Other applicable sockets selection table

								
SYF□□A-E	SYF□□A	SKF□□-E	SKF14-A	SKB□□-E	SKC□□-E	SKC14-S	SKC□□-ST	SY□□-P

Note: Applicable protection modules and accessories please refer to Page 71 to 73.

>>> RKE Miniature General Purpose Relay



RKE2CO

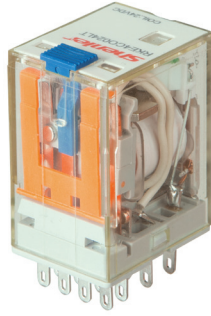

RKE4CO

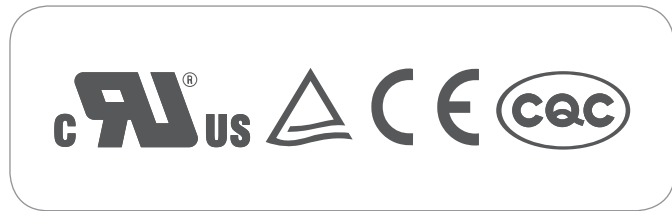

Features

- > 2 pole 7A; 4 pole 5A
- > With non-polarity LED integrated in relay
- > With lockable test button and inspection window
- > Identification of coils through test button color (AC red/DC blue)
- > Conformity with RoHS Directive

Ordering Information

RKE

Contact form _____
 2C: 2CO
 4C: 4CO

Mount options _____
 O: plug in

Coil voltage code _____

Code	006	012	024	036	048	110	220		
Voltage (V DC)	6	12	24	36	48	110	220		
Code	506	512	524	536	548	615	730	740	880
Voltage (V AC)	6	12	24	36	48	115	230	240	380

Options _____

LT: LED + test button
 LTD: LED + test button + diode (13-,14+)
 LTD1: LED + Test button + diode (13+,14-)
 A: for signal control (selection plus A, namely LTA, LTDA, LSA)

Characteristics

		2C	4C	
Contact	Configuration	2C	4C	
	Rated current/ Rated voltage	Resistive load	7A/250VAC 30VDC	5A/250VAC 30VDC
		Motor load	1/6HP 240VAC	
	Switching capacity (resistive)	1750VA, 210W	1250VA 150W	
	Initial contact resistance	≤50mΩ		
	Material	Ag alloy		
	Electric durability (110%rated voltage, 55°C)	≥20 x 10 ⁴ (1800 Ops/h)		
	Electric durability (Normal temperature)	≥40 x 10 ⁴ (360 Ops/h)		
Mechanical durability	≥2000 x 10 ⁴ (18000 Ops/h)			
Pick-up voltage (23°C)	DC:≤75% (Rated voltage), AC:≤80% 50/60Hz (Rated voltage)			
Drop-out voltage (23°C)	DC:≥10% (Rated voltage), AC:≥30% 50/60Hz (Rated voltage)			
Maximum voltage (23°C)	110% (Rated voltage)			
Insulation resistance	≥500MΩ (500VDC)			
Coil operating power	DC(W)	approx. 0.9		
	AC(VA)	approx. 1.2		
Operate time (at nominal voltage)	≤20 ms			
Release time (at nominal voltage)	≤20 ms			
Initial breakdown voltage	Between open contacts	1000VAC/1min (leakage current 1mA)		
	Between poles	2000VAC/1min (leakage current 1mA)		
	Between contacts and coil	2000VAC/1min (leakage current 1mA)		
Ambient temperature	-55~+70°C			
Humidity	35%~85%RH			
Air pressure	86~106KPa			
Shock resistance	10G (half-sine shock pulse: 11ms)			
Vibration resistance	10~55Hz double-amplitude:1.0mm			
Mounting	plug in			
Unit weight	35g			

Coil Specifications (23°C)

Nominal voltage V.DC	6	12	24	36	48	110	220		
Coil resistance Ω	40	180	640	1500	2600	13000	42000		
Nominal voltage V.AC	6	12	24	36	48	115	230	240	380
Coil resistance Ω	11.5	40	180	370	640	4430	16500	18790	42000

Remark: Coil resistance under coil voltage 110V are measured with tolerance of ±10%Ω, above coil voltage 110V are measured with tolerance of ±15%Ω.

Contact Specification

RKE2CO

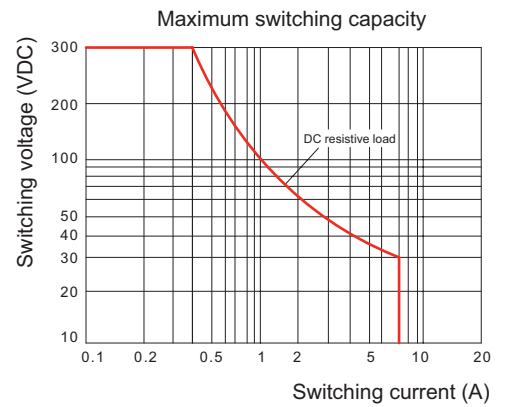
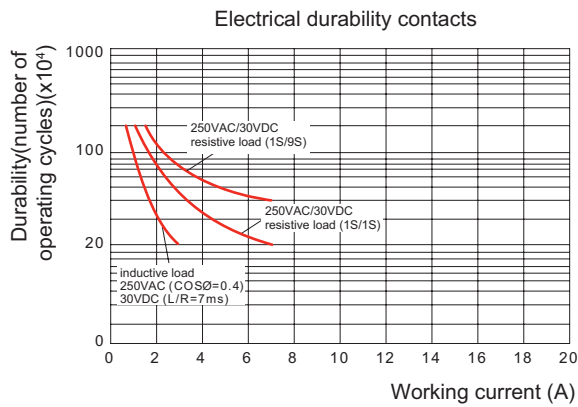

RKE4CO

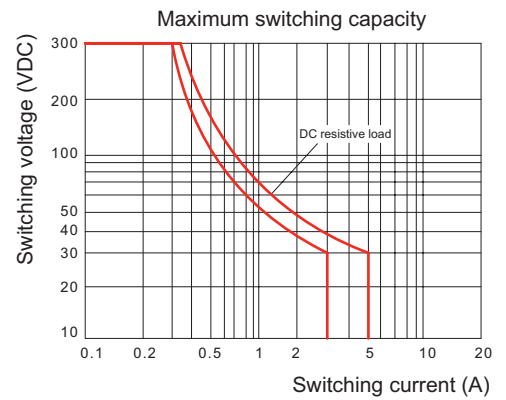
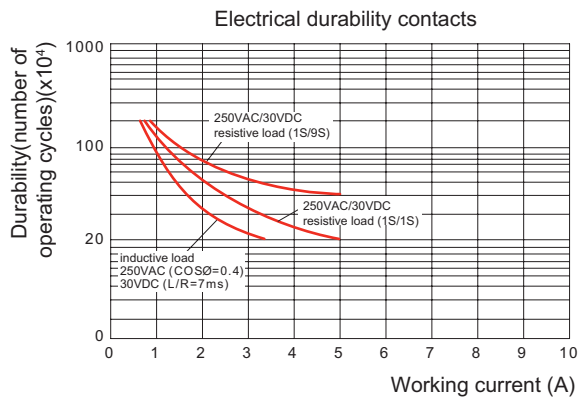

>>> RKE Miniature General Purpose Relay

Dimensions (mm)

RKE2CO

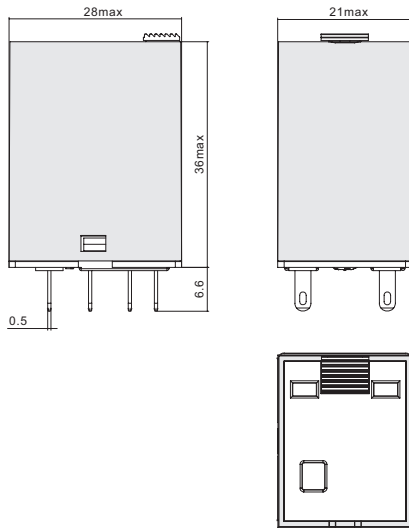

RKE4CO

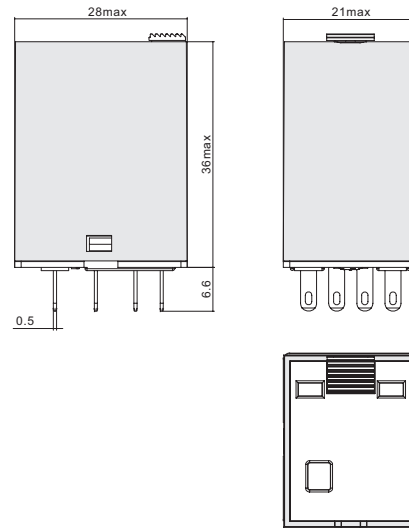

Wiring Diagrams

RKE2CO

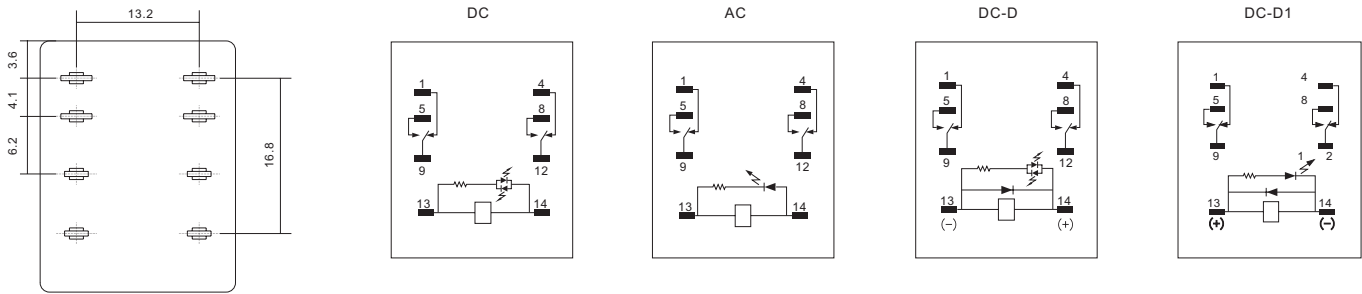

RKE4CO

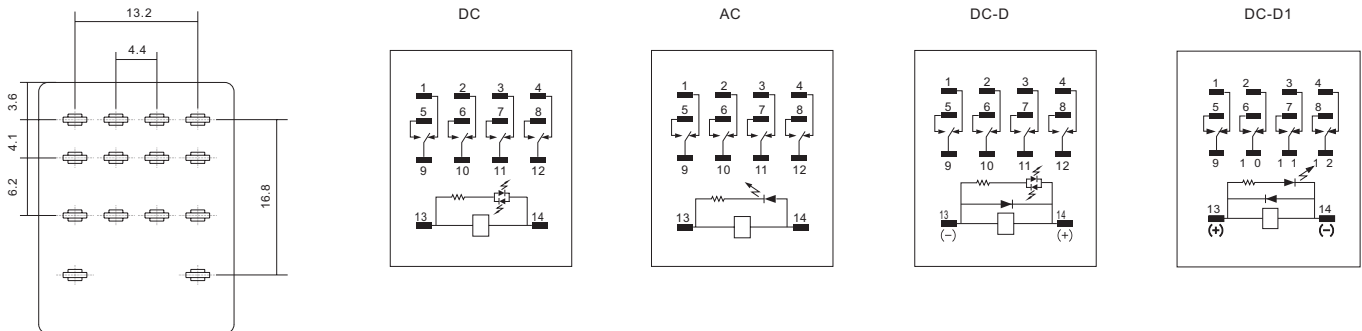

>>> RKE-LS Sealed Power Relay

Humidity proof
Oil proof
Dust proof

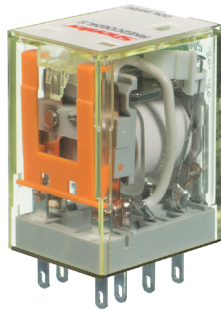

Features

- > Good performance in bad working condition, especially in much oil, dust, humidity places
- > 2 pole 7A; 4 pole 5A
- > With non-polarity LED integrated in relay
- > Conformity with RoHS Directive
- > IP62

Ordering Information

RKE

Contact form _____

2C: 2CO

4C: 4CO

Mount options _____

O: Plug in

Coil voltage code _____

Code	006	012	024	036	048	110	220		
Voltage (V DC)	6	12	24	36	48	110	220		
Code	506	512	524	536	548	615	730	740	880
Voltage (V AC)	6	12	24	36	48	115	230	240	380

Options _____

LS: LED + Sealed

LSA: LED + Sealed + Signal Control

Characteristics

		2C	4C	
Contact	Configuration	2C	4C	
	Rated current/ rated voltage	Resistive load	7A/250VAC 30VDC	5A/250VAC 30VDC
		Motor load	1/6HP 240VAC	
	Switching power (Resistive)	1750VA, 210W	1250VA 150W	
	Initial contact resistance	≤50mΩ		
	Material	Ag alloy		
	Electric durability (110% rated voltage, 55°C)	≥20 x 10 ⁴ (1800 Ops/h)		
	Electric durability (Normal temperature)	≥40 x 10 ⁴ (360 Ops/h)		
Mechanical durability	≥2000 x 10 ⁴ (18000 Ops/h)			
Pick-up voltage (23°C)	DC: ≤75% (Rated voltage), AC: ≤80% 50/60Hz (Rated voltage)			
Drop-out voltage (23°C)	DC: ≥10% (Rated voltage), AC: ≥30% 50/60Hz (Rated voltage)			
Max. voltage (23°C)	110% (Rated voltage)			
Insulation resistance	≥500MΩ (500VDC)			
Coil operating power	DC(W)	approx. 0.9		
	AC(VA)	approx. 1.2		
Operation time (rated voltage)	≤20 ms			
Release time (rated voltage)	≤20 ms			
Initial breakdown voltage	Between open contacts	1000VAC/1min (leakage current 1mA)		
	Between poles	2000VAC/1min (leakage current 1mA)		
	Between contacts and Coil	2000VAC/1min (leakage current 1mA)		
Ambient temperature	-55~+70°C			
Shock resistance	10G (half-sine shock pulse: 11ms)			
Vibration resistance	10~55Hz double-amplitude: 1.0mm			
Mounting	Plug in			
Unit weight	35g			

>>> RKE-LS Sealed Power Relay

Coil Specifications (23°C)

Nominal voltage V.DC	6	12	24	36	48	110	220		
Coil resistance Ω	40	180	640	1500	2600	13000	42000		
Nominal voltage V.AC	6	12	24	36	48	115	230	240	380
Coil resistance Ω	11.5	40	180	370	640	4430	16500	18790	42000

Remark: Coil resistance under coil voltage 110V are measured with tolerance of $\pm 10\%\Omega$, above coil voltage 110V are measured with tolerance of $\pm 15\%\Omega$.

Contact Specification

RKE2CO-LS

Electrical durability contacts

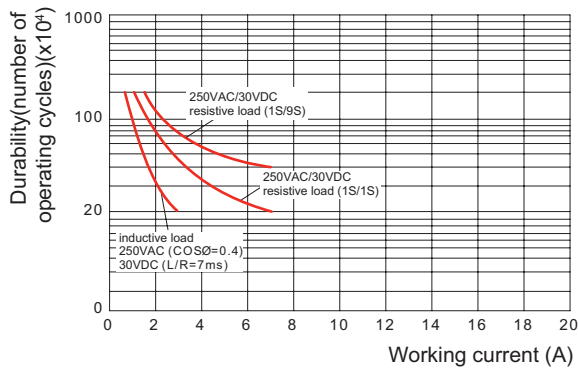

Maximum switching capacity

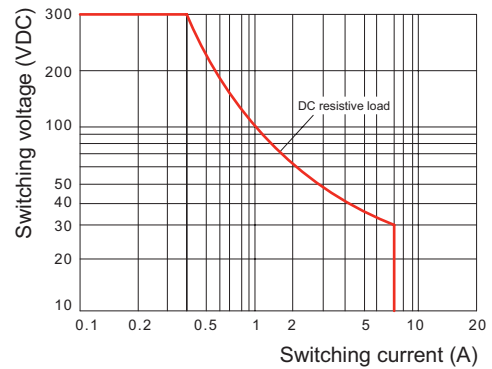

RKE4CO-LS

Electrical durability contacts

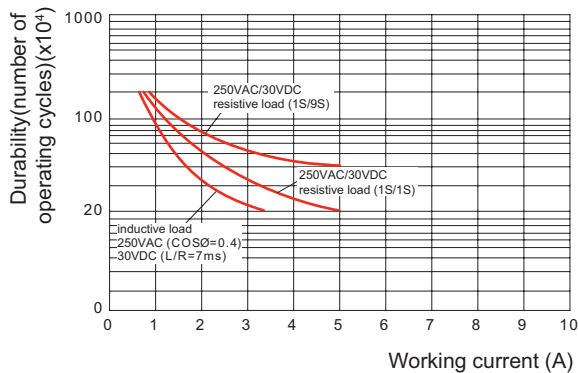

Maximum switching capacity

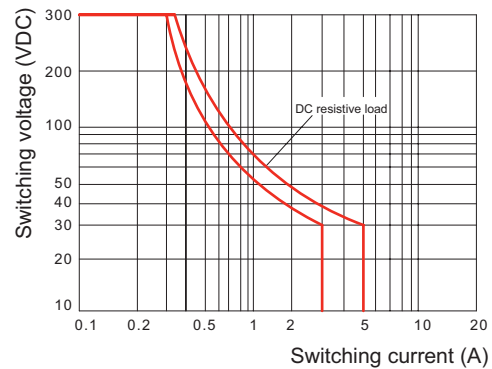

Dimensions (mm)

RKE2CO-LS

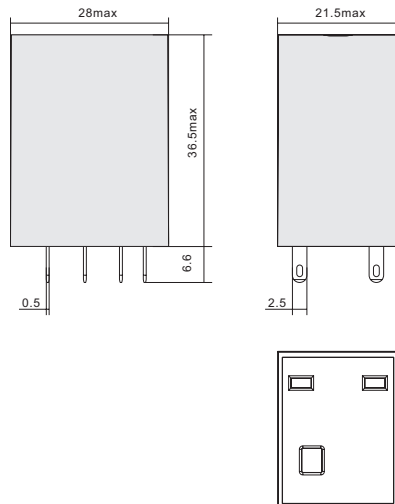

RKE4CO-LS

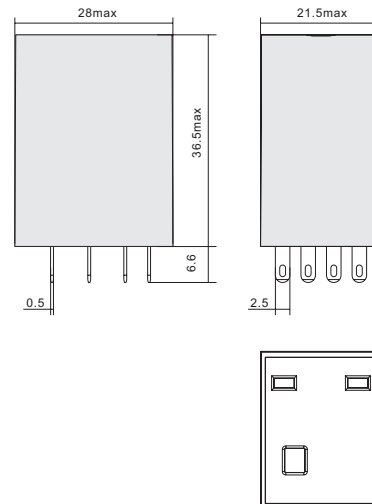

RKE Socket

>>> SYF□□A-E

Presentation



7/10 AMPS 300 VOLTS



Characteristics

Type			SYF08A-E	SYF11A-E	SYF14A-E
Nominal load	Current	A	10	7	7
	Voltage	V	300		
Dielectric strength		V/min	2000		
Max. tightening torque		Nm	1.0		
Wire size		AWG/mm ²	20-14/0.5-2.5		
Ambient temperature		°C	-40~+65		
Unit weight		g	37	56	57

Relay,accessories selection table

Socket	Plastic clip	Metal clip	ID tag	Module	DIN rail
SYF08A-E	-	-	-	-	-
SYF11A-E	-	SY36S	-	-	PFP
SYF14A-E	-	-	-	-	-

Dimensions (mm)

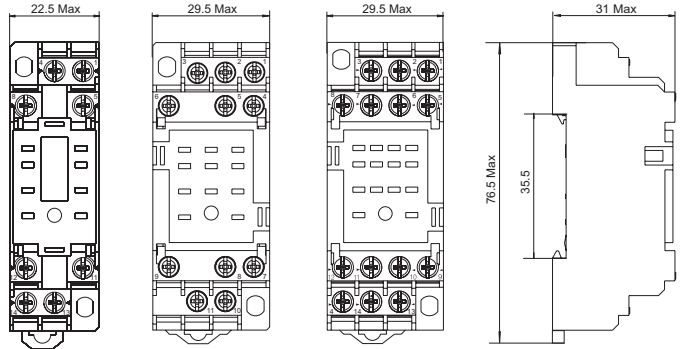

SYF08A-E SYF11A-E SYF14A-E

Connection Diagrams

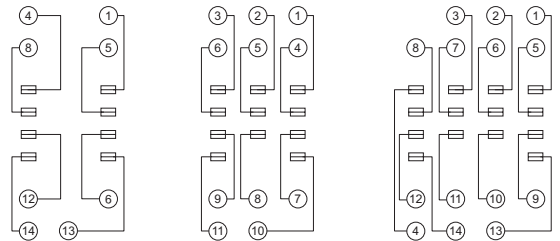

SYF08A-E

SYF11A-E

SYF14A-E

14 13 : A1 A2
1 4 : NC
5 8 : NO
9 12 : COM

10 11 : A1 A2
1 2 3 : NC
4 5 6 : NO
7 8 9 : COM

14 13 : A1 A2
1 2 3 4 : NC
5 6 7 8 : NO
9 10 11 12 : COM

>>> SKF□□-E

Presentation



10/12 AMPS 300 VOLTS



Characteristics

Type			SKF08-E	SKF14-E
Nominal load	Current	A	12	10
	Voltage	V	300	
Dielectric strength		V/min	2500	
Max. tightening torque		Nm	1	
Wire size		AWG/mm ²	20-14/0.5-2.5	
Ambient temperature		°C	-40~+85	
Unit weight		g	35	45

Relay,accessories selection table

Socket	Plastic clip	Metal clip	ID tag	Module	DIN rail
SKF08-E	-	SK36M	SK2P	-	PFP
SKF14-E	-	-	-	AMD	-

Dimensions (mm)

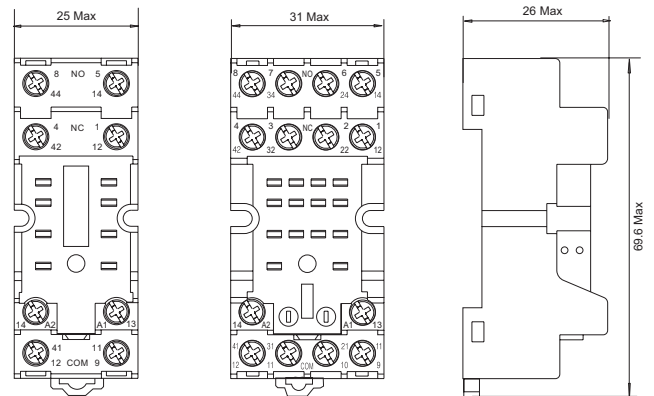

SKF08-E

SKF14-E

Connection Diagrams

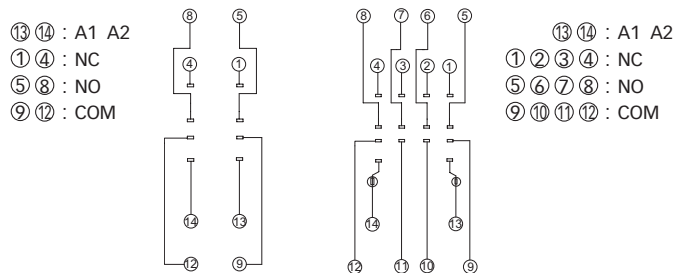

13 14 : A1 A2
1 4 : NC
5 8 : NO
9 12 : COM

13 14 : A1 A2
1 2 3 4 : NC
5 6 7 8 : NO
9 10 11 12 : COM

SKF08-E

SKF14-E

>>> RKE Miniature General Purpose Relay

RKE Socket

>>> SKB□□-E

Presentation



10/12 AMPS 300 VOLTS



Characteristics

Type			SKB08-E	SKB14-E
Nominal load	Current	A	12	10
	Voltage	V	300	
Dielectric strength	Between coil and contact	V/min	4000	
	Between contacts	V/min	2500	
Max. tightening torque	Nm		1.0	
Wire size	AWG/mm ²		20-14/0.5-2.5	
Ambient temperature	°C		-40~+85	
Unit weight	g		50	56

Relay, accessories selection table

Socket	Plastic clip	Metal clip	ID tag	Module	DIN rail
SKB08-E	SK36F	SK36M	SK4P	AMD	PFP
SKB14-E					

Dimensions (mm)

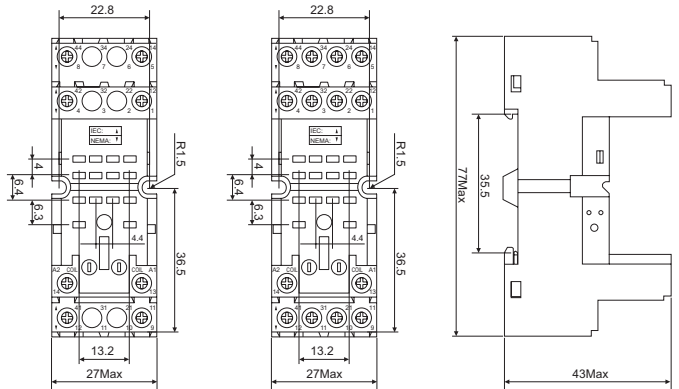

SKB08-E

SKB14-E

Connection Diagrams

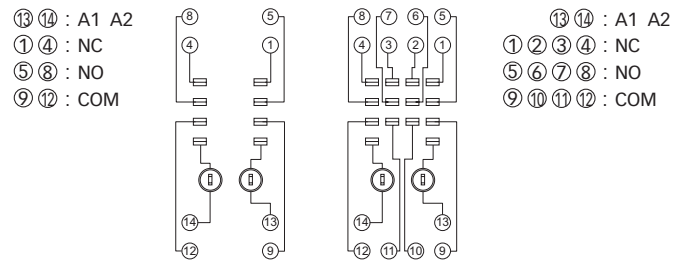

>>> SKC□□-E

Presentation



10/12 AMPS 300 VOLTS



Characteristics

Type			SKC08-E	SKC11-E	SKC14-E
Nominal load	Current	A	12	10	10
	Voltage	V	300		
Dielectric strength	Between coil and contact	V/min	4000		
	Between contacts	V/min	2500		
Max. tightening torque	Nm		1.0		
Wire size	AWG/mm ²		20-14/0.5-2.5		
Ambient temperature	°C		-40~+85		
Unit weight	g		50	56	62

Relay, accessories selection table

Socket	Plastic clip	Metal clip	ID tag	Module	DIN rail
SKC08-E	SK36F	SK36M	SK4P	AMD	PFP
SKC11-E					
SKC14-E					

Dimensions (mm)

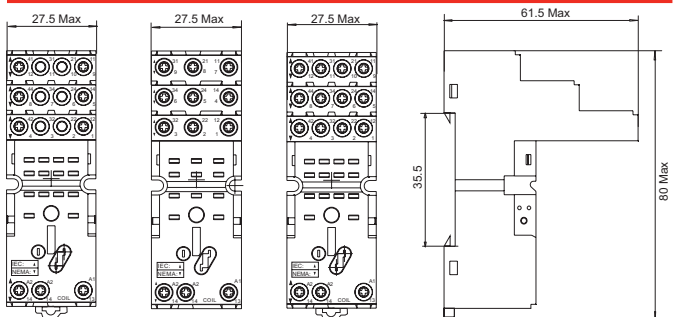

SKC08-E

SKC11-E

SKC14-E

Connection Diagrams

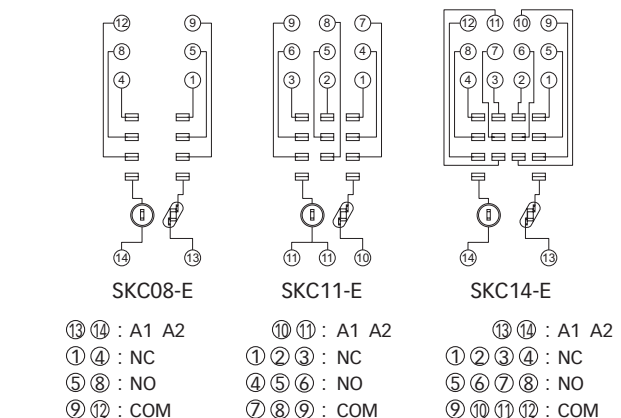

SKC08-E

SKC11-E

SKC14-E

13 14 : A1 A2
1 4 : NC
5 8 : NO
9 12 : COM

10 11 : A1 A2
1 2 3 : NC
4 5 6 : NO
7 8 9 : COM

13 14 : A1 A2
1 2 3 4 : NC
5 6 7 8 : NO
9 10 11 12 : COM

RKE Socket

▶▶▶ **SKC□□-S**

Presentation



Characteristics

Type			SKC08-S	SKC14-S
Nominal load	Current	A	12	8
	Voltage	V	300	
Dielectric strength	Between coil and contact	V/min	4000	
	Between contacts	V/min	2500	
Max. tightening torque		Nm	-	
Wire size		AWG/mm ²	20-16/0.5-1.5	
Ambient temperature		°C	-40~+85	
Unit weight		g	70	

Relay,accessories selection table

Socket	Plastic clip	ID tag	Module	DIN rail	Bus Jumper
SKC14-S	SK36F	SK4P	AMD	PFP	ST01CC

Dimensions (mm)

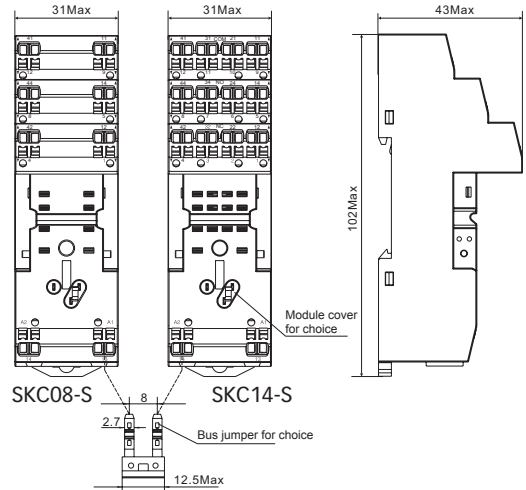

Connection Diagrams

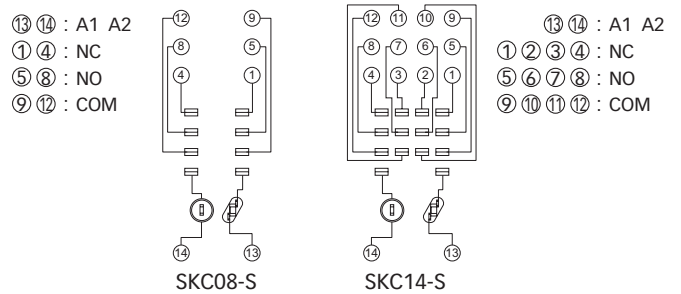

▶▶▶ **SKC□□-ST**

Presentation



New

8/12 AMPS 300VOLTS



Characteristics

Type			SKC08-ST	SKC14-ST
Nominal load	Current	A	12	8
	Voltage	V	300	
Dielectric strength	Between coil and contact	V/min	4000	
	Between contacts	V/min	2500	
Max. tightening torque		Nm	-	
Wire size		AWG/mm ²	20-16/0.5-1.5	
Ambient temperature		°C	-40~+85	
Unit weight		g	80	

Relay,accessories selection table

Socket	Plastic clip	ID tag	Module	DIN rail	Bus Jumper
SKC08-ST	SK36F	SK4P	AMD	PFP	ST01CC
SKC14-ST					

Dimensions (mm)

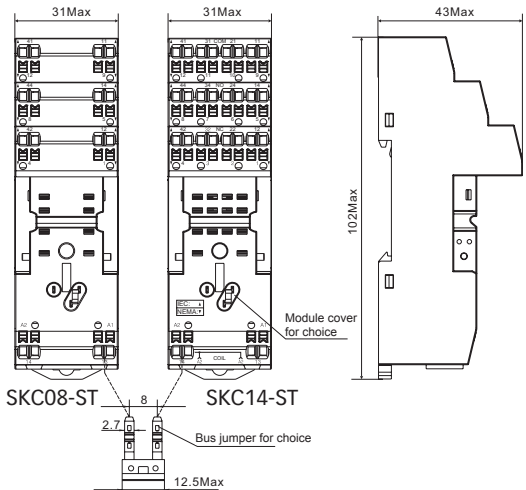

Connection Diagrams

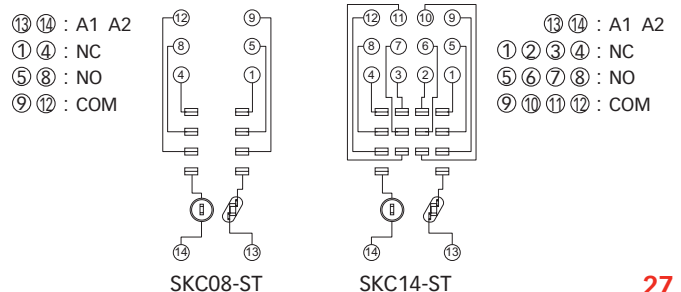

>>> RKE Miniature General Purpose Relay

RKE Socket

>>> SYF□□A

Presentation



7/10 AMPS 300 VOLTS



Characteristics

Type		SYF08A	SYF11A	SYF14A
Nominal load	Current	A	10	7
	Voltage	V	300	
Dielectric strength	V/min	2000		
Max. tightening torque	Nm	1.0		
Wire size	AWG/mm ²	20-14/0.5-2.5		
Ambient temperature	°C	-40~+65		
Unit weight	g	34	47	56

Relay, accessories selection table

Socket	Plastic clip	Metal clip	ID tag	Module	DIN rail
SYF08A	-	-	-	-	-
SYF11A	-	SY36S	-	-	PFP
SYF14A	-	-	-	-	-

Dimensions (mm)

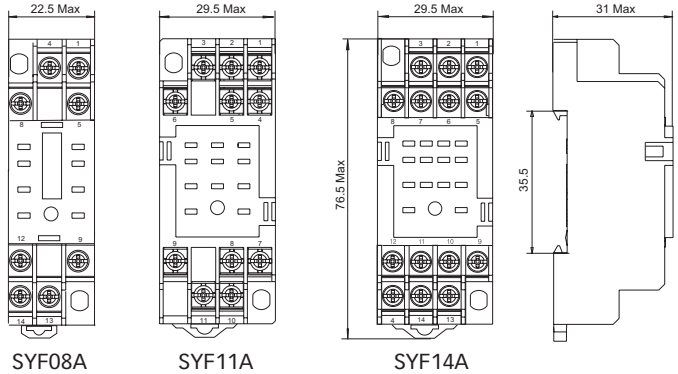

Connection Diagrams

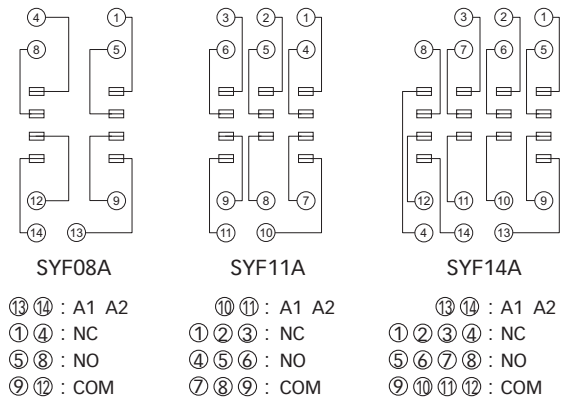

>>> SKF14-A

Presentation

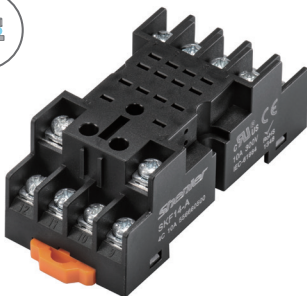

10 AMPS 300 VOLTS



Characteristics

Type		SKF14-A
Nominal load	Current	A
	Voltage	V
Dielectric strength	V/min	2500
Max. tightening torque	Nm	1.0
Wire size	AWG/mm ²	20-14/0.5-2.5
Ambient temperature	°C	-40~+85
Unit weight	g	42.9

Relay, accessories selection table

Socket	Plastic clip	Metal clip	ID tag	Module	DIN rail
SKF14-A	-	SK36M	SK2P	AMD	PFP

Dimensions (mm)

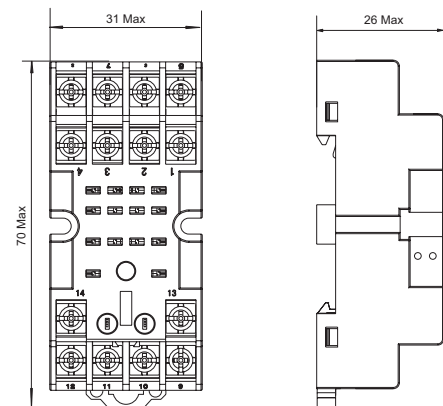

Connection Diagrams

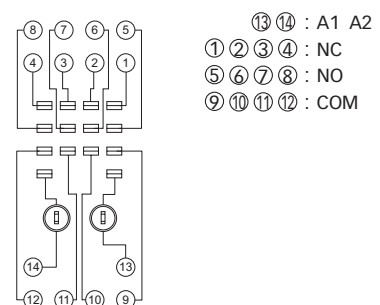

RKE Socket

>>> SY□□-P

Presentation



10/12 AMPS 300 VOLTS



Characteristics

Type			SY08-P	SY14-P
Nominal load	Current	A	12	10
	Voltage	V	300	
Dielectric strength		V/min	2000	
Ambient temperature		°C	-40~+85	
Unit weight		g	7	7

Relay accessories selection table

Socket	Plastic clip	Metal clip	ID tag	Module	DIN rail
SY08-P	-	SK36M	-	-	-
SY14-P	-				

Dimensions (mm)

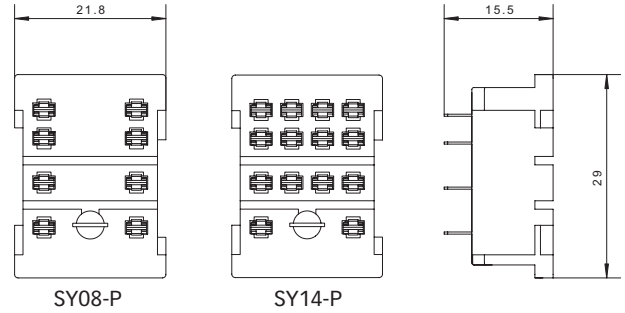

Connection Diagrams

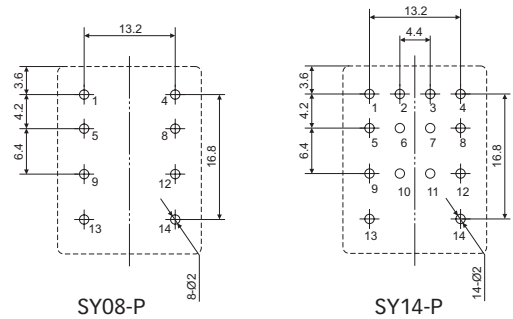

- ⑬ ⑭ : A1 A2
 ① ④ : NC
 ⑤ ⑧ : NO
 ⑨ ⑫ : COM

- ⑬ ⑭ : A1 A2
 ① ② ③ ④ : NC
 ⑤ ⑥ ⑦ ⑧ : NO
 ⑨ ⑩ ⑪ ⑫ : COM

>>> RKF Miniature General Purpose Relay



>>> Other applicable sockets selection table

						
SKF14-A	SKF□□-E	SKB□□-E	SKC□□-E	SKC14-S	SKC□□-ST	SY□□-P

Note: Applicable protection modules and accessories please refer to Page 71 to 73.



RKF2CO

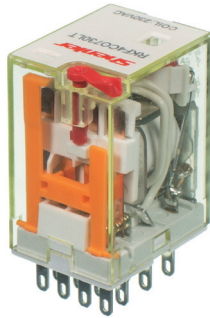

RKF4CO



Features

- > 2 pole 12A; 4 pole 6A
- > With non-polarity LED integrated in relay
- > With lockable test button and inspection window
- > Identification of coils through test button color (AC red/DC blue)
- > Conformity with RoHs Directive
- > Gold plated contacts optional

Ordering Information

RKF

Contact form _____
 2C: 2CO
 4C: 4CO

Mount options _____
 O: plug in

Coil voltage code _____

Code	006	012	024	036	048	110	220		
Voltage (V DC)	6	12	24	36	48	110	220		
Code	506	512	524	536	548	615	730	740	880
Voltage (V AC)	6	12	24	36	48	115	230	240	380

- Options _____
- LT: LED + test button
 - LTD: LED + test button + diode (13-, 14+)
 - LTD1: LED + Test button + diode (13+, 14-)
 - LT A: LED + test button + gold plated contact
 - LTD A: LED + test button + diode+gold plated contact

Characteristics

		2C	4C
Contact	Configuration		
	Rated current/Resistive load	12A/250VAC 30VDC	6A/250VAC 30VDC
	Rated voltage/Motor load	1/3HP,240VAC	1/6HP,240VAC
	Switching capacity (resistive)	3000VA, 360W	1500VA 180W
	Initial contact resistance	≤50mΩ	
	Material	Ag alloy	
	Electric durability (110%rated voltage, 55°C)	≥20 x 10 ⁴ (1800 Ops/h)	
	Electric durability (Normal temperature)	≥40 x 10 ⁴ (360 Ops/h)	
	Mechanical durability	≥2000 x 10 ⁴ (18000 Ops/h)	
	Pick-up voltage (23°C)	DC: ≤75% (Rated voltage), AC: ≤80% 50/60Hz (Rated voltage)	
Drop-out voltage (23°C)	DC: ≥10% (Rated voltage), AC: ≥30% 50/60Hz (Rated voltage)		
Maximum voltage (23°C)	110% (Rated voltage)		
Insulation resistance	≥1000MΩ (500VDC)		
Coil operating power	DC(W)	approx. 0.9	
	AC(VA)	approx. 1.2	
Operate time (at nominal voltage)	≤20 ms		
Release time (at nominal voltage)	≤20 ms		
Initial breakdown voltage	Between open contacts	1000VAC/1min (leakage current 1mA)	
	Between poles	2000VAC/1min (leakage current 1mA)	
	Between contacts and coil	2000VAC/1min (leakage current 1mA)	
Ambient temperature	-55~+70°C		
Humidity	35%~85%RH		
Air pressure	86~106KPa		
Shock resistance	10G (half-sine shock pulse: 11ms)		
Vibration resistance	10~55Hz double-amplitude:1.0mm		
Mounting	plug in		
Unit weight	35g		

>>> RKF Miniature General Purpose Relay

Coil Specifications (23°C)

Nominal voltage V.DC	6	12	24	36	48	110	220		
Coil resistance Ω	40	180	640	1500	2600	13000	42000		
Nominal voltage V.AC	6	12	24	36	48	115	230	240	380
Coil resistance Ω	11.5	40	180	370	640	4430	16500	18790	42000

Remark: Coil resistance under coil voltage 110V are measured with tolerance of $\pm 10\% \Omega$, above coil voltage 110V are measured with tolerance of $\pm 15\% \Omega$.

Contact Specification

RKF2C

Electrical durability contacts

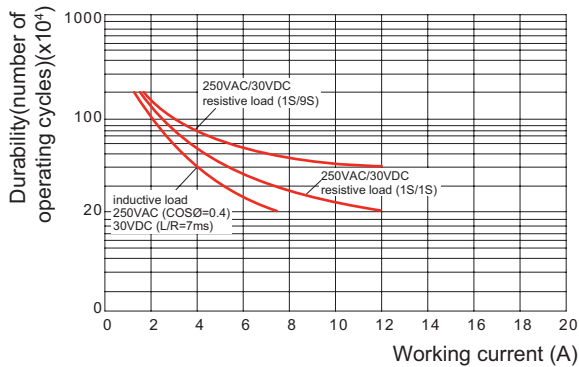

Maximum switching capacity

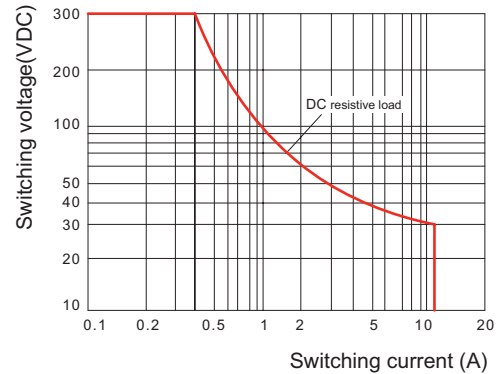

RKF4C

Electrical durability contacts

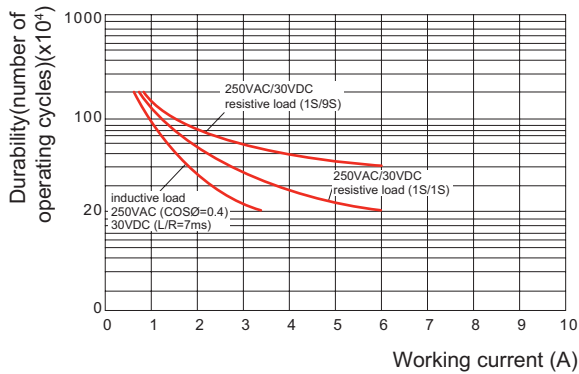

Maximum switching capacity

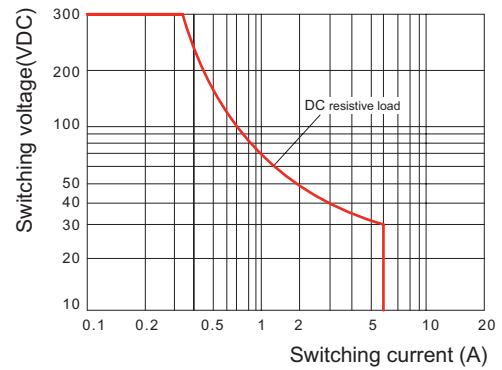

Dimensions (mm)

RKF2CO

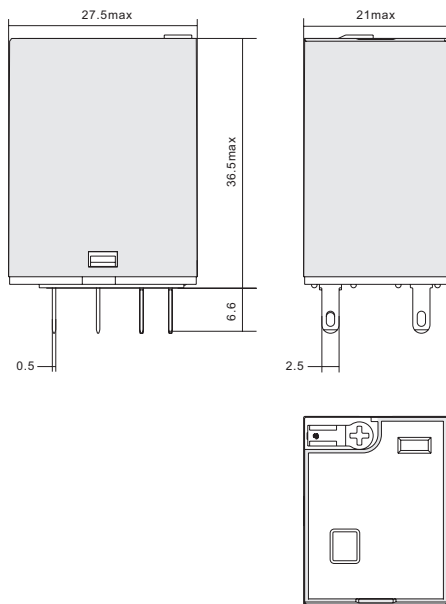

RKF4CO

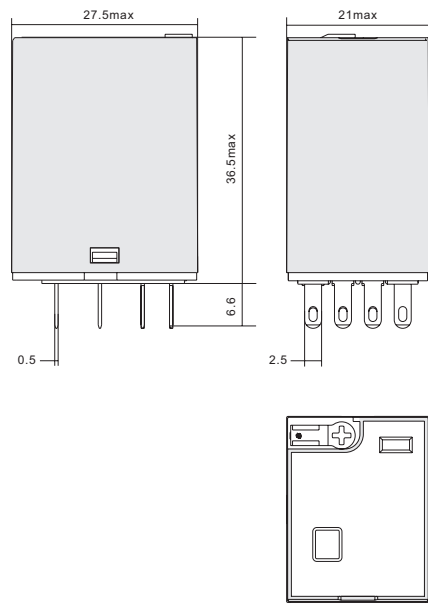

Wiring Diagrams

RKF2CO

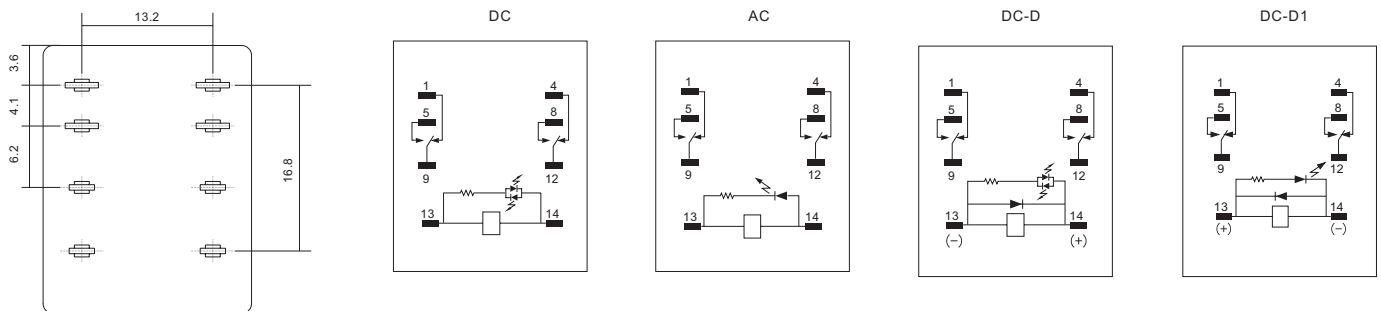

RKF4CO

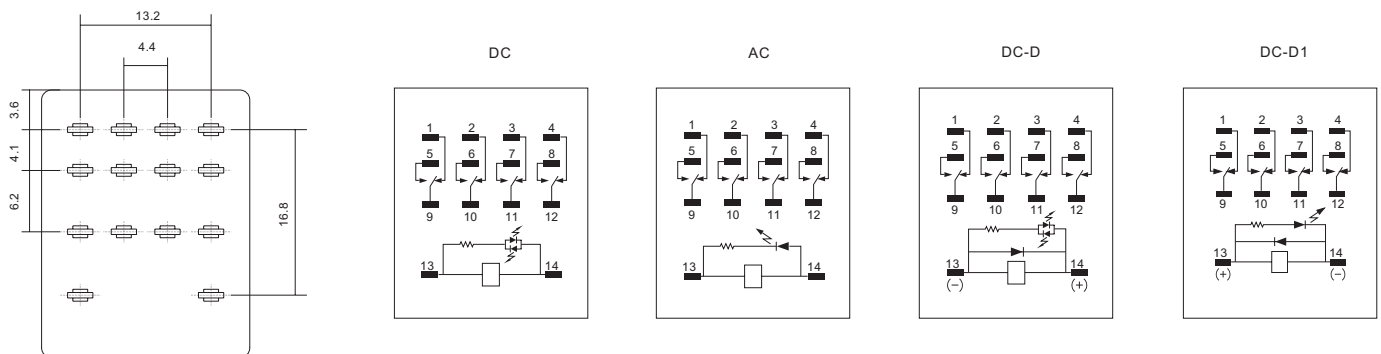

>>> RKF Magnetic Blow-out Power Relay

New



RKF2CO024LTS



Features

- > Good performance for motor load application.
- > With non-polarity LED, lockable test and inspection window
- > Identification of coil through test button color (AC red / DC blue)

Ordering Information

RKF

Contact form _____
2C : 2CO

Mount options _____
O: plug in

Coil voltage code _____

Code	006	012	024	036	048	110	220		
Voltage (V DC)	6	12	24	36	48	110	220		
Code	506	512	524	536	548	615	730	740	880
Voltage (V AC)	6	12	24	36	48	115	230	240	380

Options _____

LTS: LED + test button+magnet
 LTDS: LED + test button +diode (13 - , 14 +) +magnet
 LTD1S: LED + test button + diode (13 + , 14 -) +magnet

Characteristics

Contact	Configuration	2C	
	Rated current/ Rated voltage	Resistive load	15A/250VAC 30VDC (NO:15A, NC:7.5A); 10A 60VDC
		Motor load	1/3HP,240VAC
	Switching capacity (resistive)	3750VA, 600W	
	Switching capacity (perceptual)	2500VA, 90W	
	Initial contact resistance	≤50mΩ	
	Material	Ag alloy	
	Electric durability (110% rated voltage, 55°C)	≥10 x 10 ⁴ (NO/NC:15A); ≥20 x 10 ⁴ (NO/NC:12A)(1800 Ops/h)	
	Mechanical durability	≥2000 x 10 ⁴ (18000 Ops/h)	
	Pick-up voltage (23°C)	DC: ≤75% (Rated voltage), AC: ≤80% 50/60Hz (Rated voltage)	
Drop-out voltage (23°C)	DC: ≥10% (Rated voltage), AC: ≥30% 50/60Hz (Rated voltage)		
Maximum voltage (23°C)	110% (Rated voltage)		
Insulation resistance	1000MΩ (500VDC)		
Coil operating power	DC(W)	approx. 0.9	
	AC(VA)	approx. 1.2	
Operate time (at nominal voltage)	≤20 ms		
Release time (at nominal voltage)	≤20 ms		
Initial breakdown voltage	Between open contacts	1000VAC/1min (leakage current 1mA)	
	Between poles	2000VAC/1min (leakage current 1mA)	
	Between contacts and coil	2000VAC/1min (leakage current 1mA)	
Ambient temperature	-55~+70°C		
Humidity	35%~85%RH		
Air pressure	86~106KPa		
Shock resistance	10G (half-sine shock pulse: 11ms)		
Vibration resistance	10~55Hz double-amplitude:1.0mm		
Mounting	plug in		
Unit weight	35g		

Coil Specifications (23°C)

Nominal voltage V.DC	6	12	24	36	48	110	220	
Coil resistance Ω	40	180	640	1500	2600	13000	42000	
Nominal voltage V.AC	6	24	36	48	115	230	240	380
Coil resistance Ω	11.5	180	370	640	4430	16500	18790	42000

Remark: Coil resistance under coil voltage 110V are measured with tolerance of ± 10%Ω, above coil voltage 110V are measured with tolerance of ± 15%Ω.

Contact Specification

RKF2CO

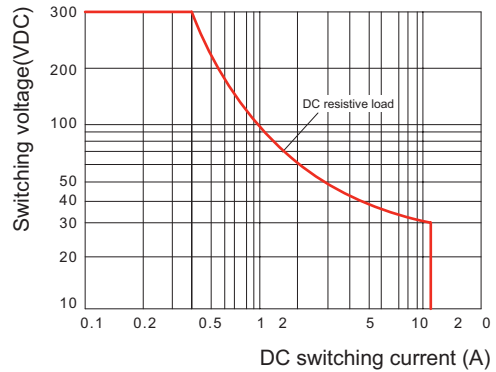
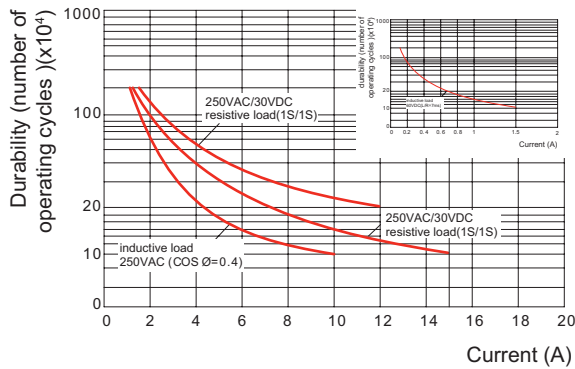

Dimensions (mm)

RKF2CO

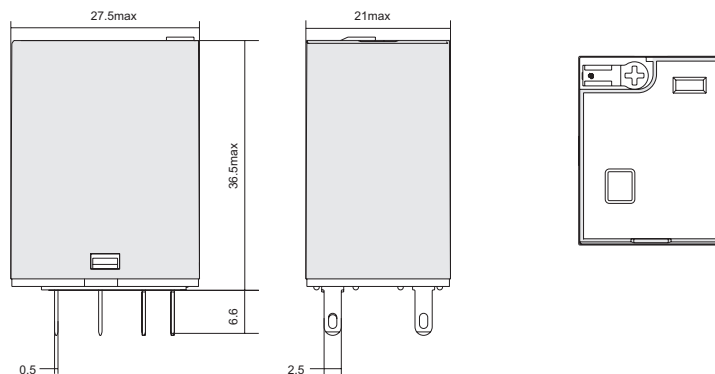

Wiring Diagrams

RKF2CO

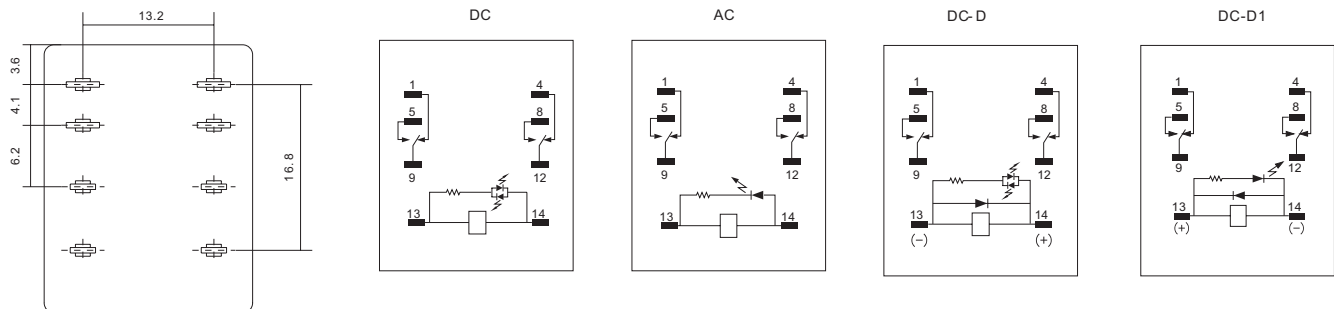

>>> RKF Miniature General Purpose Relay

RKF Socket

>>> SKF□□-E

Presentation



10/12 AMPS 300 VOLTS



Characteristics

Type			SKF08-E	SKF14-E
Nominal load	Current	A	12	10
	Voltage	V	300	
Dielectric strength	V/min		2500	
Max. tightening torque	Nm		1	
Wire size	AWG/mm ²		20-14/0.5-2.5	
Ambient temperature	°C		-40~+85	
Unit weight	g		35	45

Relay, accessories selection table

Socket	Plastic clip	Metal clip	ID tag	Module	DIN rail
SKF08-E	-	SK36M	SK2P	-	PFP
SKF14-E	-			AMD	

Dimensions (mm)

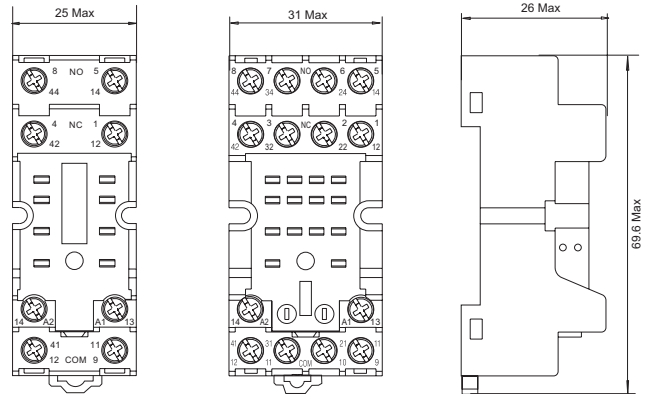

SKF08-E

SKF14-E

Connection Diagrams

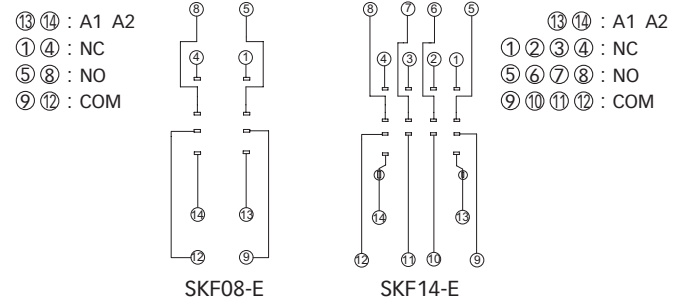

SKF08-E

SKF14-E

>>> SKB□□-E

Presentation



10/12 AMPS 300 VOLTS



Characteristics

Type			SKB08-E	SKB14-E
Nominal load	Current	A	12	10
	Voltage	V	300	
Dielectric strength	Between coil and contact	V/min	4000	
	Between contacts	V/min	2500	
Max. tightening torque	Nm		1.0	
Wire size	AWG/mm ²		20-14/0.5-2.5	
Ambient temperature	°C		-40~+85	
Unit weight	g		50	56

Relay, accessories selection table

Socket	Plastic clip	Metal clip	ID tag	Module	DIN rail
SKB08-E	SK36F	SK36M	SK4P	AMD	PFP
SKB14-E					

Dimensions (mm)

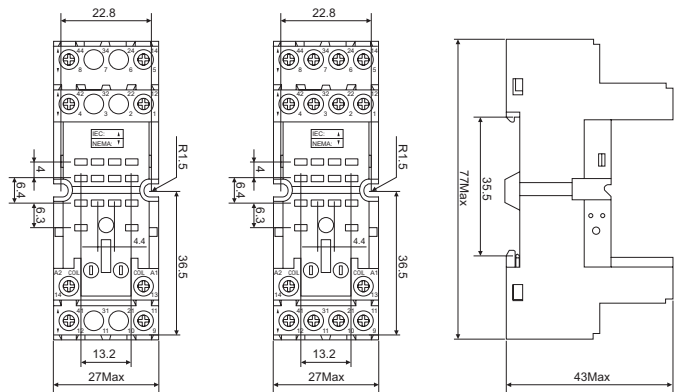

SKB08-E

SKB14-E

Connection Diagrams

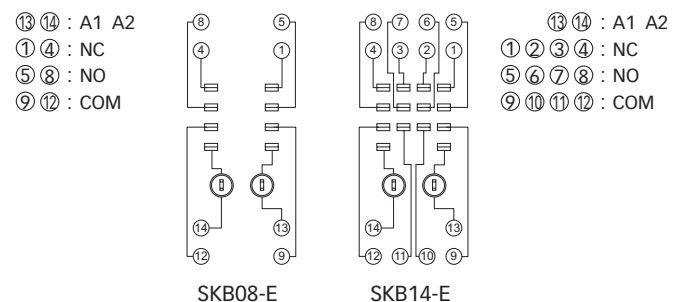

SKB08-E

SKB14-E

RKF Socket

>>> SKC□□-E

Presentation



10/12 AMPS 300 VOLTS



Characteristics

Type			SKC08-E	SKC11-E	SKC14-E
Nominal load	Current	A	12	10	10
	Voltage	V	300		
Dielectric strength	Between coil and contact	V/min	4000		
	Between contacts	V/min	2500		
Max. tightening torque		Nm	1.0		
Wire size		AWG/mm ²	20-14/0.5-2.5		
Ambient temperature		°C	-40~+85		
Unit weight		g	50	56	62

Relay,accessories selection table

Socket	Plastic clip	Metal clip	ID tag	Module	DIN rail
SKC08-E					
SKC11-E	SK36F	SK36M	SK4P	AMD	PPF
SKC14-E					

>>> SKC□□-S

Presentation



2C 12A; 4C 8A



Characteristics

Type			SKC08-S	SKC14-S
Nominal load	Current	A	12	8
	Voltage	V	300	
Dielectric strength	Between coil and contact	V/min	4000	
	Between contacts	V/min	2500	
Max. tightening torque		Nm	-	
Wire size		AWG/mm ²	20-16/0.5-1.5	
Ambient temperature		°C	-40~+85	
Unit weight		g	70	

Relay,accessories selection table

Socket	Plastic clip	ID tag	Module	DIN rail	Bus Jumper
SKC14-S	SK36F	SK4P	AMD	PPF	ST01CC

Dimensions (mm)

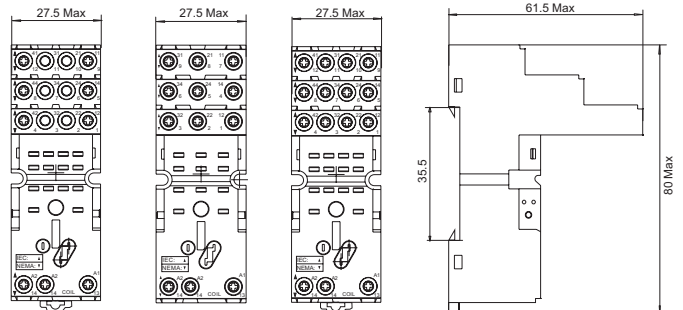

SKC08-E

SKC11-E

SKC14-E

Connection Diagrams

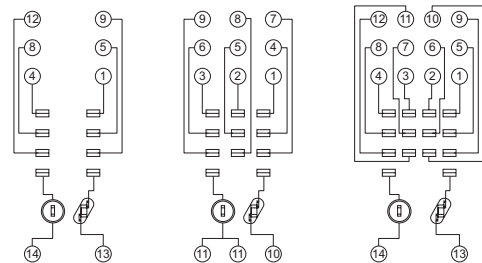

SKC08-E

SKC11-E

SKC14-E

⑬ ⑭ : A1 A2
① ④ : NC
⑤ ⑧ : NO
⑨ ⑫ : COM

⑩ ⑪ : A1 A2
① ② ③ : NC
④ ⑤ ⑥ : NO
⑦ ⑧ ⑨ : COM

⑬ ⑭ : A1 A2
① ② ③ ④ : NC
⑤ ⑥ ⑦ ⑧ : NO
⑨ ⑩ ⑪ ⑫ : COM

Dimensions (mm)

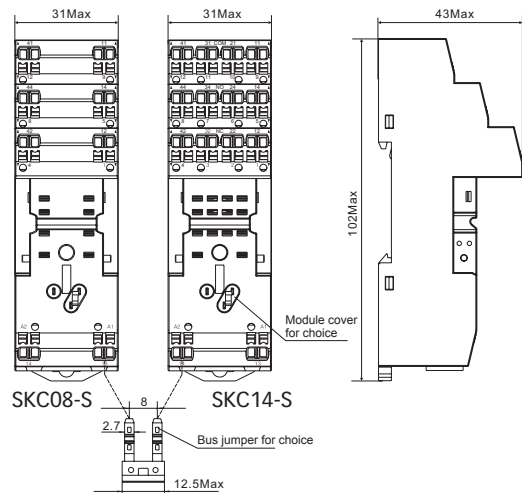

SKC08-S

SKC14-S

Connection Diagrams

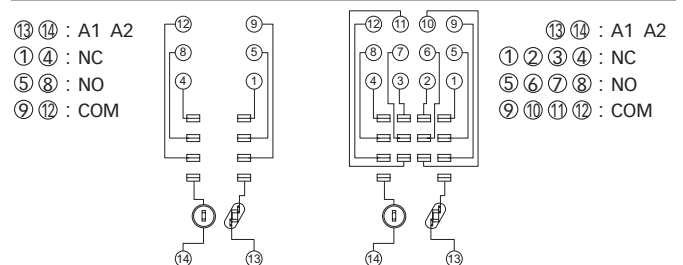

SKC08-S

SKC14-S

>>> RKF Miniature General Purpose Relay

RKF Socket

>>> SKC□□-ST

Presentation



New



8/12 AMPS 300VOLTS



Characteristics

Type			SKC08-ST	SKC14-ST
Nominal load	Current	A	12	8
	Voltage	V	300	
Dielectric strength	Between coil and contact	V/min	4000	
	Between contacts	V/min	2500	
Max. tightening torque	Nm		-	
Wire size	AWG/mm ²		20-16/0.5-1.5	
Ambient temperature	°C		-40~+85	
Unit weight	g		80	

Relay,accessories selection table

Socket	Plastic clip	ID tag	Module	DIN rail	Bus Jumper
SKC08-ST	SK36F	SK4P	AMD	PFP	ST01CC
SKC14-ST					

Dimensions (mm)

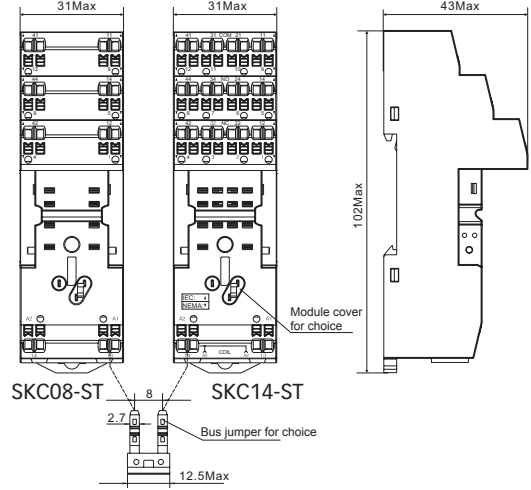

Connection Diagrams

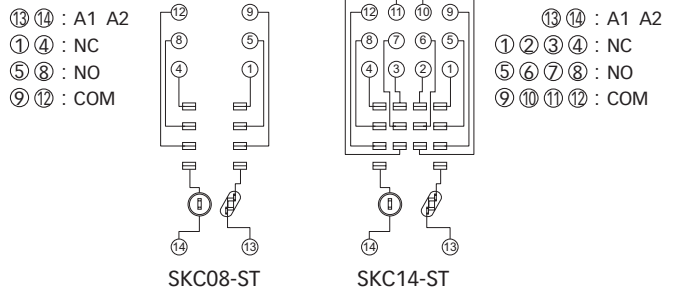

>>> SKF14-A

Presentation

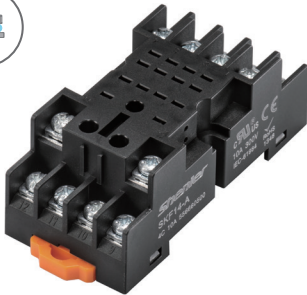

10 AMPS 300 VOLTS



Characteristics

Type			SKF14-A
Nominal load	Current	A	10
	Voltage	V	300
Dielectric strength	V/min		2500
Max. tightening torque	Nm		1.0
Wire size	AWG/mm ²		20-14/0.5-2.5
Ambient temperature	°C		-40~+85
Unit weight	g		42.9

Relay,accessories selection table

Socket	Plastic clip	Metal clip	ID tag	Module	DIN rail
SKF14-A	-	SK36M	SK2P	AMD	PFP

Dimensions (mm)

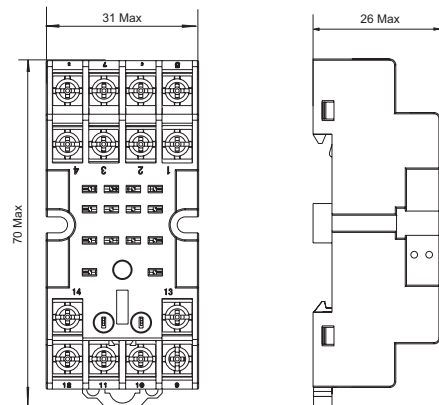

Connection Diagrams

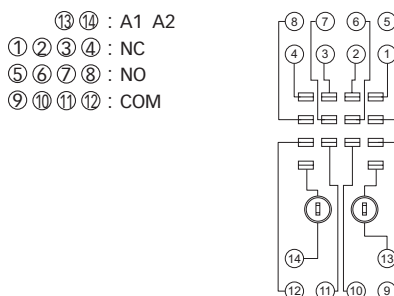

RKF Socket

>>> SY□□-P

Presentation



10/12 AMPS 300 VOLTS



Characteristics

Type			SY08-P	SY14-P
Nominal load	Current	A	12	10
	Voltage	V	300	
Dielectric strength		V/min	2000	
Ambient temperature		°C	-40~+85	
Unit weight		g	7	7

Relay accessories selection table

Socket	Plastic clip	Metal clip	ID tag	Module	DIN rail
SY08-P	-	SK36M	-	-	-
SY14-P	-				

Dimensions (mm)

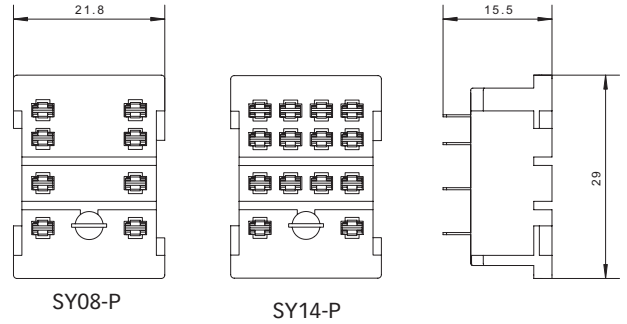

Connection Diagrams

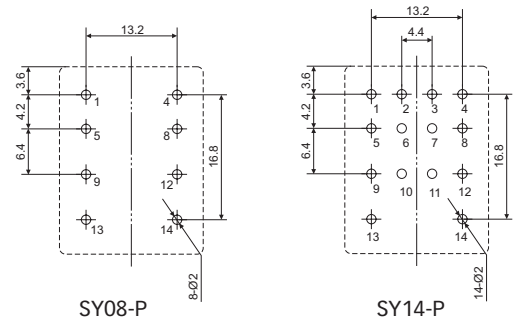

- ⑬ ⑭ : A1 A2
 ① ④ : NC
 ⑤ ⑧ : NO
 ⑨ ⑫ : COM

- ⑬ ⑭ : A1 A2
 ① ② ③ ④ : NC
 ⑤ ⑥ ⑦ ⑧ : NO
 ⑨ ⑩ ⑪ ⑫ : COM

>>> RKL Miniature Power Relay

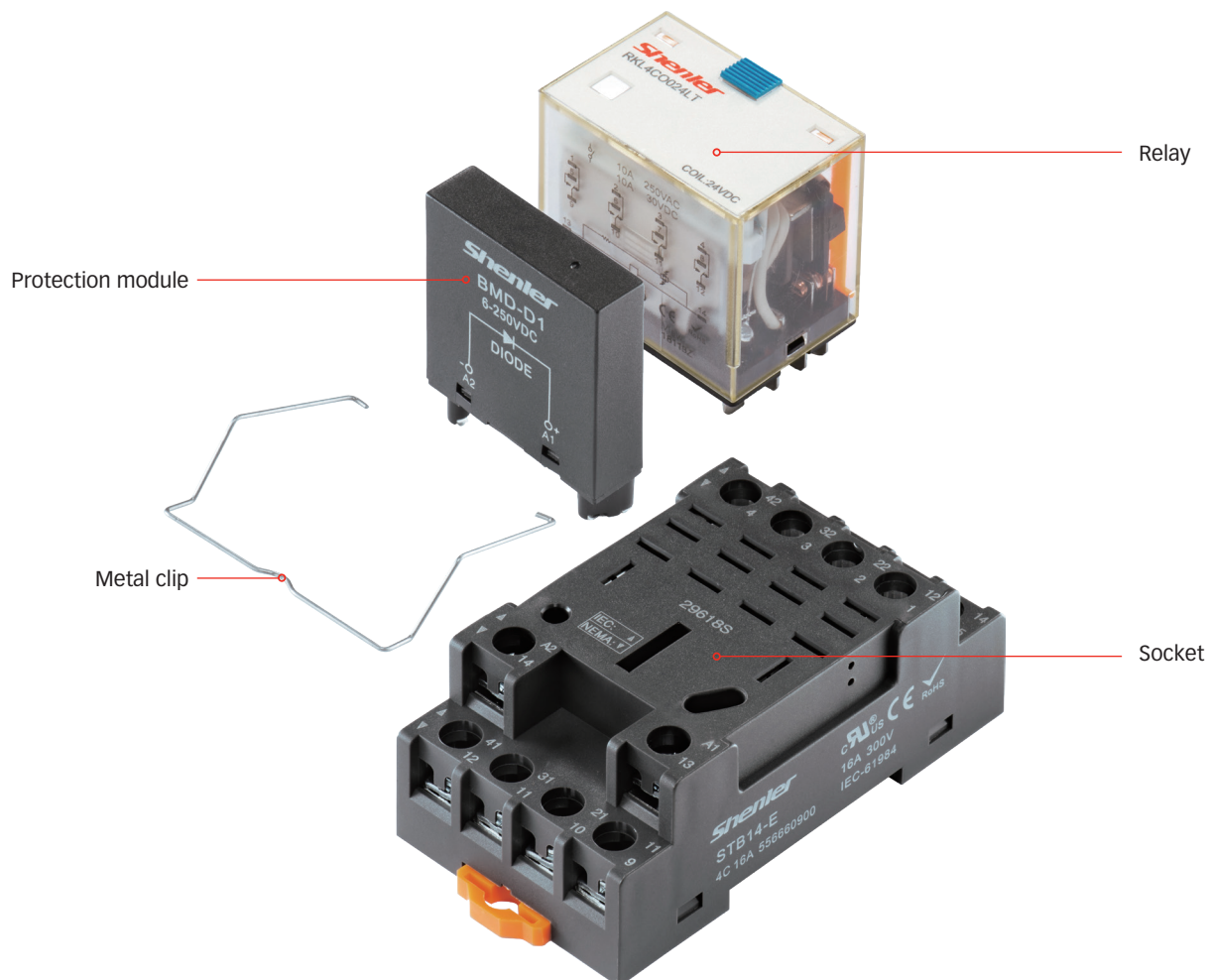

Note: Applicable protection modules and accessories please refer to Page 71 to 73.



RKL2CO

RKL4CO



Features

- > 1 pole 16A; 2,3,4 pole 10A
- > With non-polarity LED integrated in relay
- > With lockable test button and inspection window
- > Identification of coils through test button color (AC red/DC blue)
- > Conformity with RoHS Directive

Ordering Information

RKL

Contact form _____

1C: 1CO
2C: 2CO
3C: 3CO
4C: 4CO

Mount options _____

O: plug in

Coil voltage code _____

Code	006	012	024	036	048	110	220		
Voltage (V DC)	6	12	24	36	48	110	220		
Code	506	512	524	536	548	615	730	740	880
Voltage (V AC)	6	12	24	36	48	115	230	240	380

Options

- LT: LED + test button
LTD: LED + test button + diode (13-, 14+)
LTD1: LED + Test button + diode (13+, 14-)

Characteristics

Configuration		1C	2C	3C	4C
Contact	Rated current/ Rated voltage	Resistive load 16A/250VAC 30VDC	10A/250VAC 30VDC		
		Motor load 1/2HP, 120VAC; 1HP, 240VAC	1/3HP 240VAC	1/6HP 240VAC	
	Switching capacity (resistive)	4000VA, 480W	2500VA 300W		
	Initial contact resistance	≤50mΩ			
	Material	Ag alloy			
	Electrical durability	1C/3C/4C: ≥10 x 10 ⁴ (1800 ops/h), 2C: ≥20 x 10 ⁴ (1800 ops/h)			
	Mechanical durability	≥1000 x 10 ⁴ (18000 ops/h)			
Pick-up voltage (23°C)	DC: ≤75% (Rated voltage), AC: ≤80% 50/60Hz (Rated voltage)				
Drop-out voltage (23°C)	DC: ≥10% (Rated voltage), AC: ≥30% 50/60Hz (Rated voltage)				
Maximum voltage (23°C)	110% (Rated voltage)				
Insulation resistance	≥500MΩ (500VDC)				
Coil operating power	DC(W)	approx. 0.9	approx. 0.9	approx. 1.4	approx. 1.5
	AC(VA)	approx. 1.2	approx. 1.2	approx. 2	approx. 2.5
Operate time (at nominal voltage)	≤20 ms				
Release time (at nominal voltage)	≤20 ms				
Initial breakdown voltage	Between open contacts	1000VAC/1min (leakage current 1mA)			
	Between poles	2000VAC/1min (leakage current 1mA)			
	Between contacts and coil	2000VAC/1min (leakage current 1mA)			
Ambient temperature	-25~+55°C				
Humidity	35%~85%RH				
Air pressure	86~106KPa				
Shock resistance	10G (half-sine shock pulse: 11ms)				
Vibration resistance	10~55Hz double-amplitude:1.0mm				
Mounting	plug in				
Unit weight	approx. 35g	approx. 35g	approx. 50g	approx. 65g	

>>> RKL Miniature Power Relay

Coil Specifications (23°C)

RKL1, RKL2

Nominal voltage V.DC	6	12	24	36	48	110	220		
Coil resistance Ω	40	180	640	1500	2600	13000	42000		
Nominal voltage V.AC	6	12	24	36	48	115	230	240	380
Coil resistance Ω	11.5	40	180	370	640	4430	16500	18790	42000

RKL3

Nominal voltage V.DC	6	12	24	36	48	110	220		
Coil resistance Ω	25	100	400	900	1600	8400	33000		
Nominal voltage V.AC	6	12	24	36	48	115	230	240	380
Coil resistance Ω	6.5	25.5	102	230	410	2500	10000	10000	26000

RKL4

Nominal voltage V.DC	6	12	24	36	48	110	220		
Coil resistance Ω	24	96	360	865	1500	6800	29000		
Nominal voltage V.AC	6	12	24	36	48	115	230	240	380
Coil resistance Ω	5	20	80	180	320	1680	8000	8000	20000

Remark: Coil resistance under coil voltage 110V are measured with tolerance of $\pm 10\% \Omega$, above coil voltage 110V are measured with tolerance of $\pm 15\% \Omega$.

Contact Specification

RKL1CO

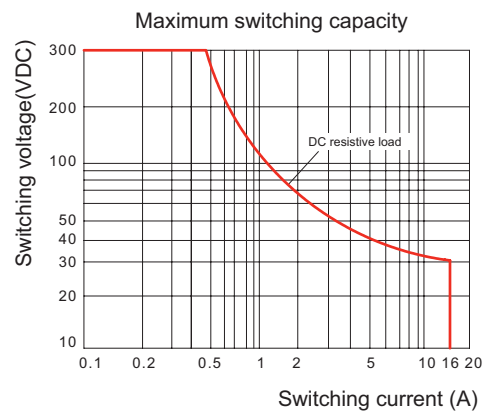
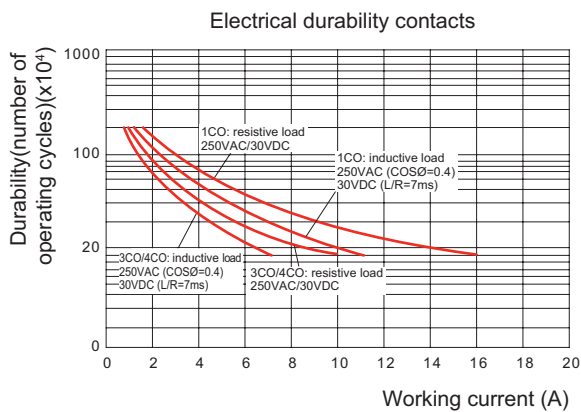

RKL2CO/3CO/4CO

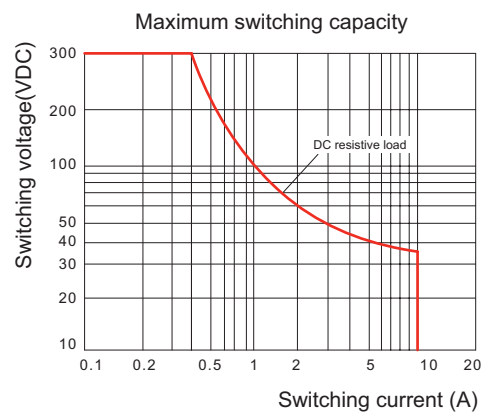
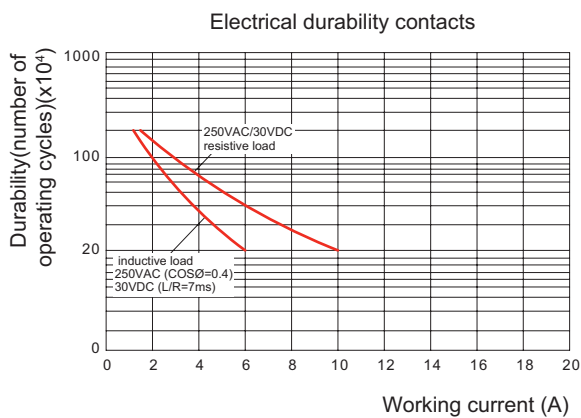

Dimensions (mm)

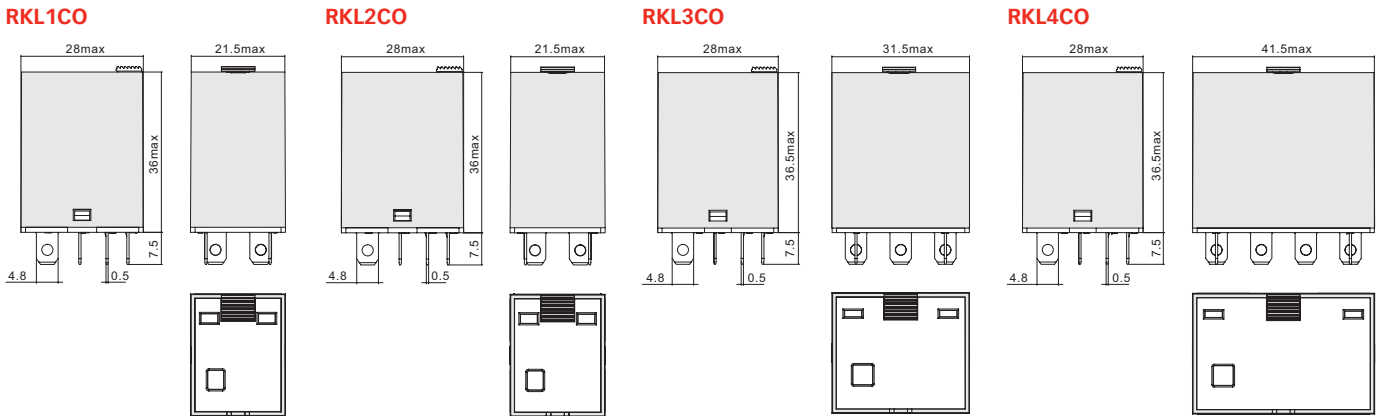

Wiring Diagrams

RKL1CO

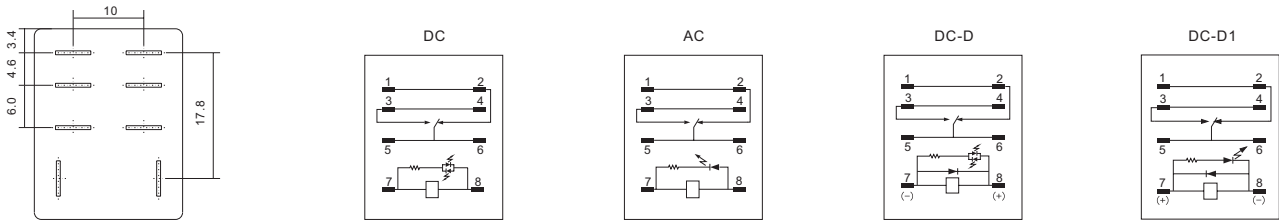

RKL2CO

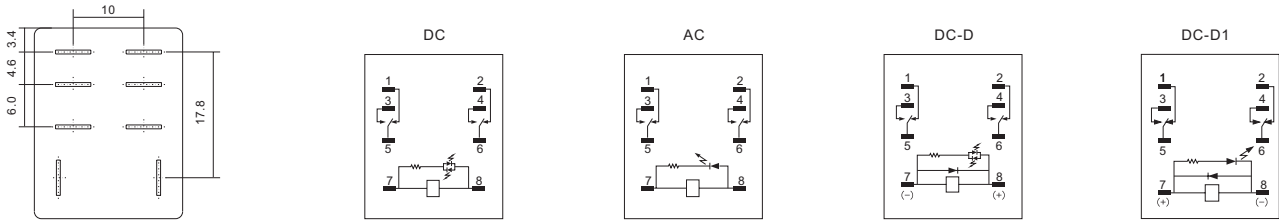

RKL3CO

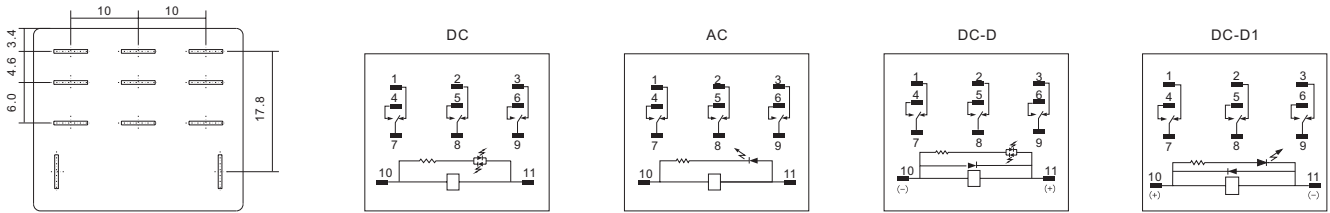

RKL4CO

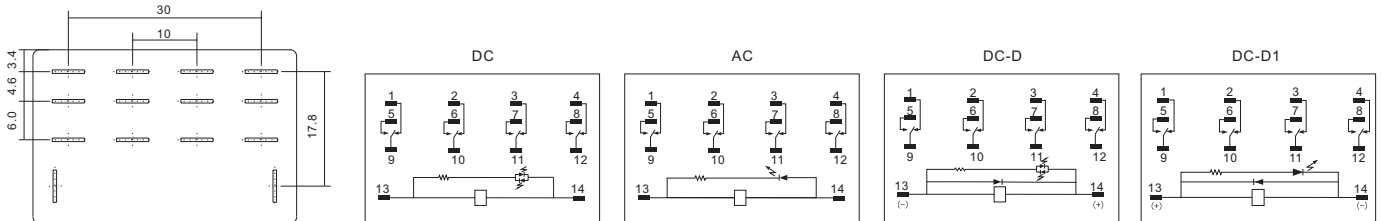

>>> RKL Miniature Power Relay

RKL Socket

>>> STB□□-E

Presentation



16 AMPS 300 VOLTS



Dimensions (mm)

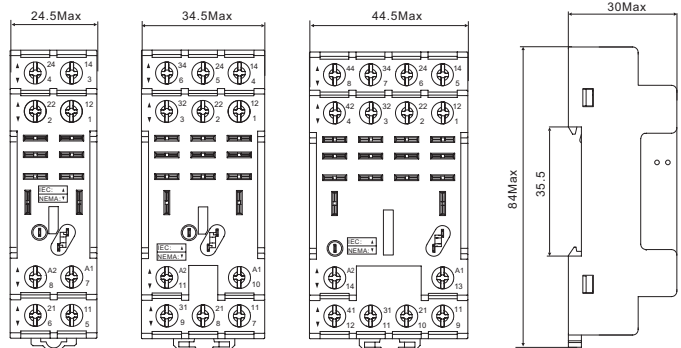

STB08-E

STB11-E

STB14-E

Characteristics

Type		STB08-E	STB11-E	STB14-E
Nominal load	Current	A 16		
	Voltage	V 300		
Dielectric strength	Between coil and contact	V/min 4000		
	Between contacts	V/min 2500		
Max. tightening torque	Nm	1.2		
Wire size	AWG/mm ²	20-14/0.5-2.5		
Ambient temperature	°C	-40~+85		
Unit weight	g	46	62	78

Relay,accessories selection table

Socket	Plastic clip	Metal clip	ID tag	Module	DIN rail
STB08-E	-	SK36M	-	AMD	PFP
STB11-E		ST36M3C		BMD	
STB14-E		ST36M4C			

Connection Diagrams

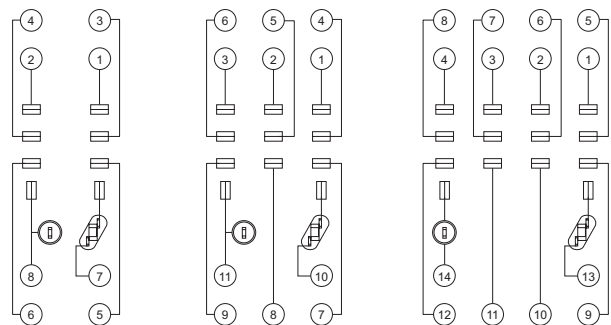

STB08-E

STB11-E

STB14-E

⑬ ⑭ : A1 A2
① ④ : NC
⑤ ⑧ : NO
⑨ ⑫ : COM

⑩ ⑪ : A1 A2
① ② ③ : NC
④ ⑤ ⑥ : NO
⑦ ⑧ ⑨ : COM

⑬ ⑭ : A1 A2
① ② ③ ④ : NC
⑤ ⑥ ⑦ ⑧ : NO
⑨ ⑩ ⑪ ⑫ : COM

>>> REH Power Relay

Shenler
Industrial Relay Series

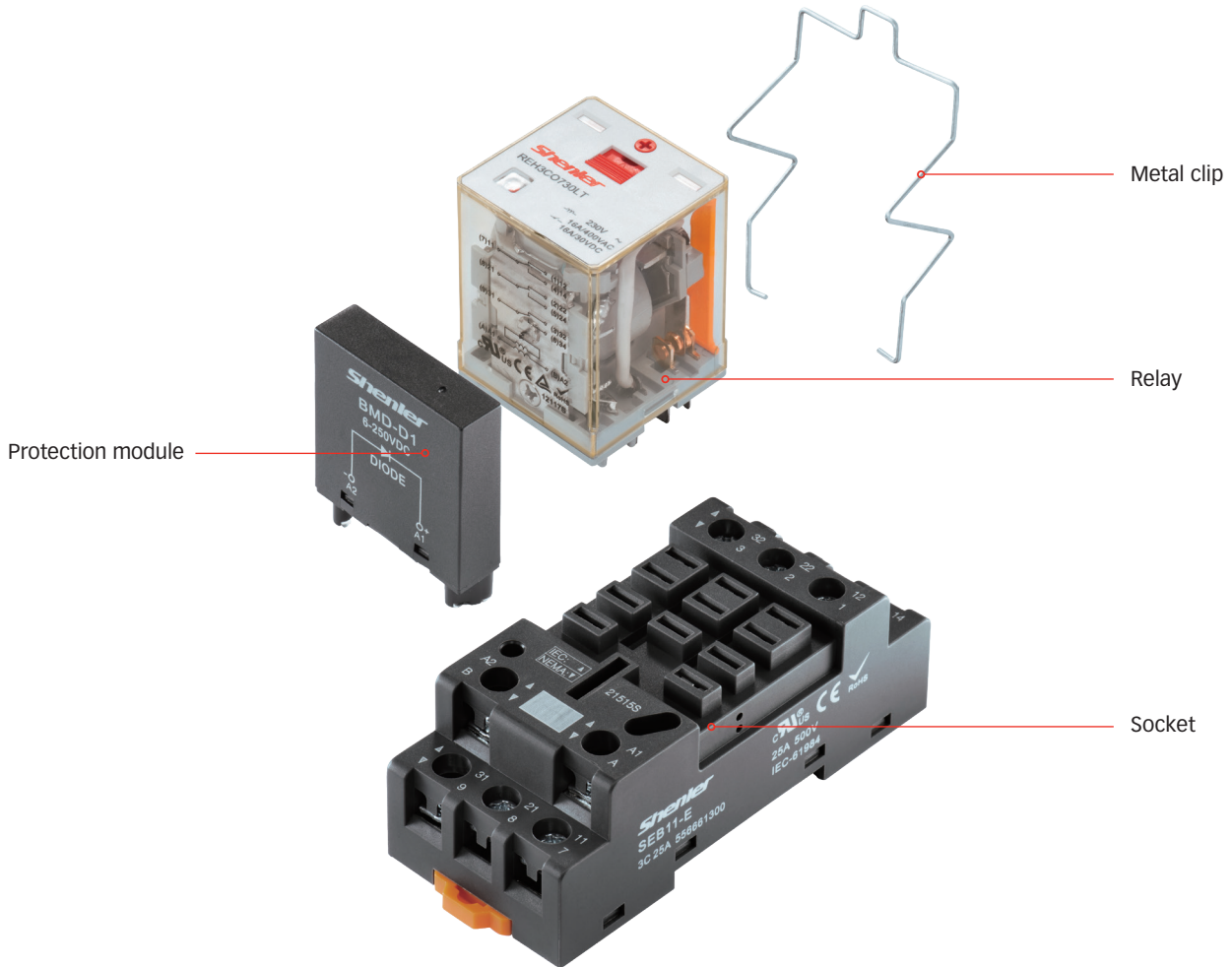

>>> Other applicable sockets selection table



SEB11-P

Note: Applicable protection modules and accessories please refer to Page 71 to 73.

>>> REH Power Relay

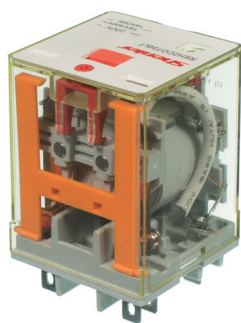

REH2CO



REH3CO

Features

- > 2 pole 3 pole contact load 16A
- > With non-polarity LED integrated in relay
- > With lockable test button and inspection window
- > Identification of coils through test button color (AC red/DC blue)
- > Conformity with RoHS Directive

Ordering Information

REH

Contact form _____

2C: 2CO

3C: 3CO

Mount options _____

O: plug in

Coil voltage code _____

Code	006	012	024	048	110	220	
Voltage (V DC)	6	12	24	48	110	220	
Code	506	524	548	615	730	880	900
Voltage (V AC)	6	24	48	115	230	380	400

Options _____

LT: LED + test button

LTD: LED + test button + diode (A1-, A2+)

LTD1: LED + Test button + diode (A1+, A2-)



Characteristics

Contact	Configuration	2C, 3C	
	Rated current/ Rated voltage	Resistive load	16A/400VAC 30VDC
		Motor load	1/2HP, 120VAC; 1HP, 240VAC
	Switching capacity (resistive)	6400VA, 480W	
	Initial contact resistance	≤50mΩ	
	Material	Ag alloy	
	Electrical durability	≥60 x 10 ⁴ (600 ops/h)	
	Mechanical durability	≥5000 x 10 ⁴ (18000 ops/h)	
Pick-up voltage (23°C)	DC: ≤75% (Rated voltage), AC: ≤80% 50/60Hz (Rated voltage)		
Drop-out voltage (23°C)	DC: ≥10% (Rated voltage), AC: ≥30% 50/60Hz (Rated voltage)		
Maximum voltage (23°C)	110% (Rated voltage)		
Insulation resistance	≥1000MΩ (500VDC)		
Coil operating power	DC(W)	approx. 1.5	
	AC(VA)	approx. 2.5	
Operate time (at nominal voltage)	≤20 ms		
Release time (at nominal voltage)	≤20 ms		
Initial breakdown voltage	Between open contacts	1500VAC/1min (leakage current 1mA)	
	Between poles	4000VAC/1min (leakage current 1mA)	
	Between contacts and coil	4000VAC/1min (leakage current 1mA)	
Ambient temperature	-40~+55°C		
Humidity	35%~85%RH		
Air pressure	86~106KPa		
Shock resistance	10G (half-sine shock pulse: 11ms)		
Vibration resistance	10~55Hz double-amplitude: 1.0mm		
Mounting	plug in		
Unit weight	approx. 90g		

Coil Specifications (23°C)

Nominal voltage V.DC	6	12	24	48	110	220	
Coil resistance Ω	25	100	400	1600	8400	33000	
Nominal voltage V.AC	6	24	48	115	230	380	400
Coil resistance Ω	8	100	350	2200	8000	26000	27000

Remarks: Coil resistances under 10000Ω are measured with tolerances of ±10%Ω; above coil resistances 10000Ω are measured with tolerances of ±15%Ω.

Contact Specification

REH2CO/3CO

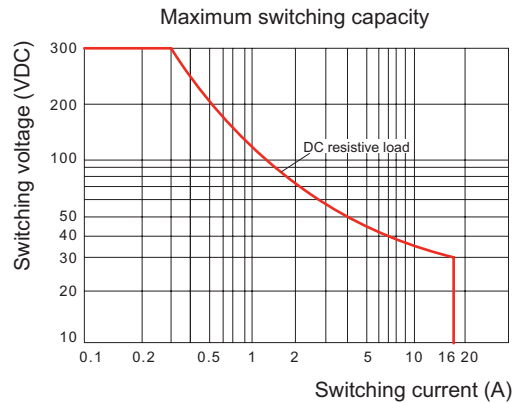
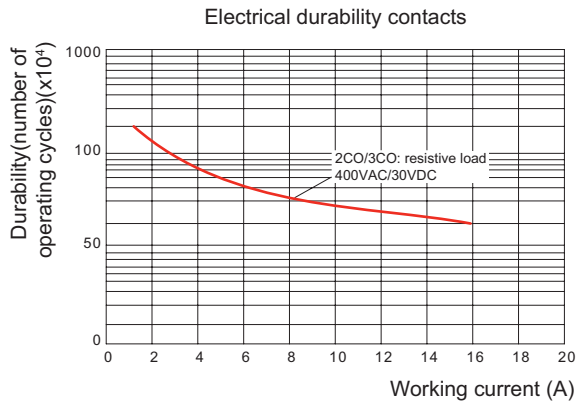

Dimensions (mm)

REH2CO

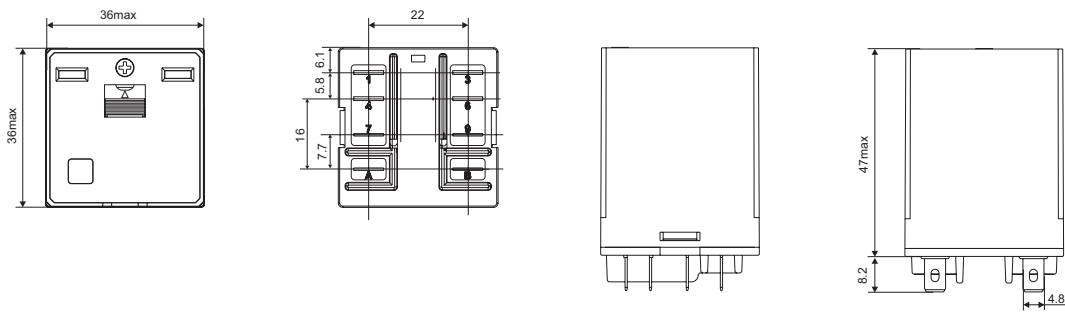

REH3CO

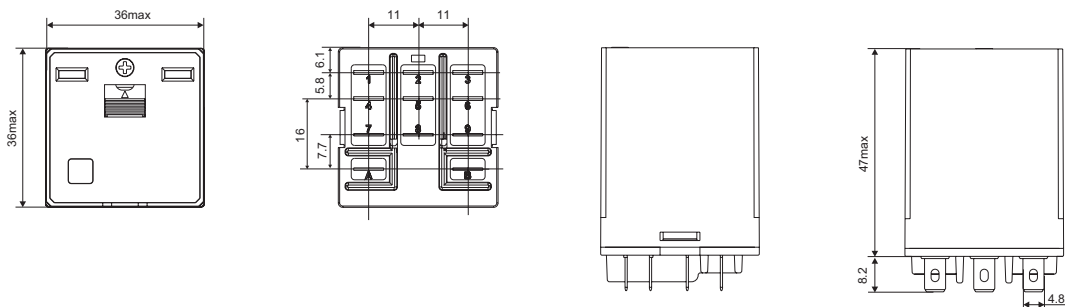

Wiring Diagrams

REH2CO

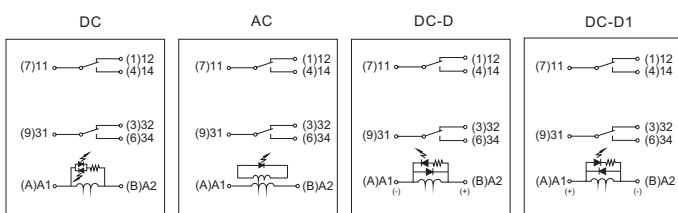

REH3CO

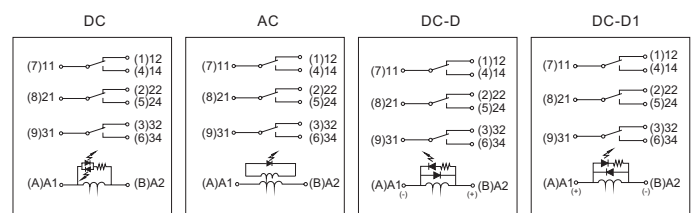

>>> REH Magnetic Blow-out Power Relay

New



REH1AO

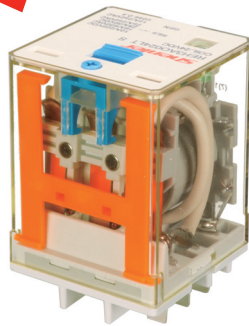

REH3AO

Features

- > Good performance in DC motor load
- > High capacity load (16A@400VAC) for well replacement of contactor
- > With blow-out magnet
- > With non-polarity LED and lockable test button.
- > Identification of coil through test button color (AC red /DC blue)

Ordering Information

REH

Contact form _____

Code	1A	1B	1C	2A	2B	2C	3A
Contact form	1 NO	1 NC	1 CO	2 NO	2 NC	2 CO	3 NO

Mount options _____

O: plug in

Coil voltage code _____

Code	012	024	048	110	220	
Voltage (V DC)	12	24	48	110	220	
Code	524	548	615	730	880	900
Voltage (V AC)	24	48	115	230	380	400

Options _____

LTS: LED +test button + magnet



Characteristics

		1A/2A	3A	
Contcat	Configuration	1A/2A	3A	
	Rated current/ Rated voltage	Resistance	16A/400VAC	16A/400VAC; 25A/250VAC
		Resistance	16A/30VDC; 10A/220VDC	10A/220VDC; 25A/30VDC
		inductive	3A/220VDC	12A/250VAC(cosØ0.4);3A/220VDC(L/R=7ms)
	Switching capacity	Resistance	6400VA	6400VA; 6250VA
		Resistance	480W; 2200W	2200VA; 750W
		inductive	660W	3000VA(cosØ0.4); 660W(L/R=7ms)
	Initial contact resistance	≤50mΩ		
	Material	Ag alloy		
	Electrical durability	≥20 x 10 ⁴ (600 Ops/h)	≥60 x 10 ⁴ (600 Ops/h)	
Mechanical durability	≥5000 x 10 ⁴ (18000 Ops/h)			
Pick-up voltage (23°C)	DC:≤75% (Rated voltage), AC:≤80% 50/60Hz (Rated voltage)			
Drop-out voltage (23°C)	DC:≥10% (Rated voltage),AC:≥30% 50/60Hz (Rated voltage)			
Maximum voltage (23°C)	110% (Rated voltage)			
Insulation resistance	≥1000MΩ (500VDC)			
Coil operating power	DC(W)	approx. 1.5		
	AC(VA)	approx. 2.5		
Operate time (at nominal voltage)	≤20 ms			
Release time (at nominal voltage)	≤20 ms			
Initial breakdown voltage	Between open contacts	1500VAC/1min (leakage current 1mA)		
	Between poles	4000VAC/1min (leakage current 1mA)		
	Between contacts and coil	4000VAC/1min (leakage current 1mA)		
Ambient temperature	-40~+55°C			
Humidity Air pressure	35%~85%RH			
Air pressure	86~106KPa			
Shock resistance	10G (half-sine shock pulse: 11ms)			
Vibration resistance	10~55Hz double-amplitude:1.0mm			
Mounting	plug in			
Unit weight	approx. 90g			

Coil Specifications (23°C)

Nominal voltage V.DC	12	24	48	110	220	
Coil resistance Ω	100	400	1600	8400	33000	
Nominal voltage V.AC	24	48	115	230	380	400
Coil resistance Ω	100	350	2200	8000	26000	27000

Remarks: Coil resistances under 10000Ω are measured with tolerances of ±10%Ω; above coil resistances 10000Ω are measured with tolerances of ±15%Ω.

Contact Specification

REH1AO/2AO

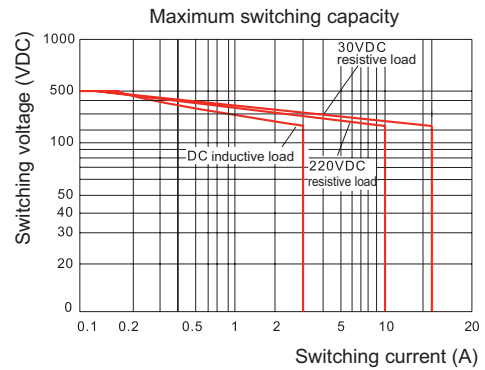
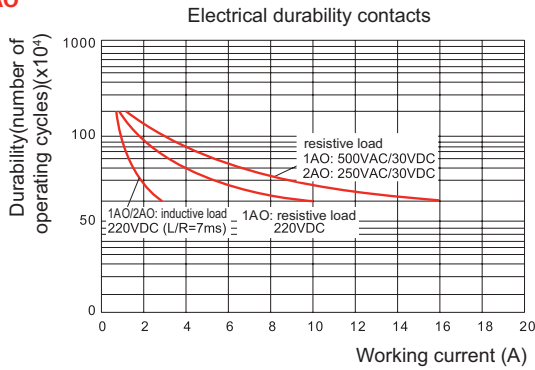

REH3AO

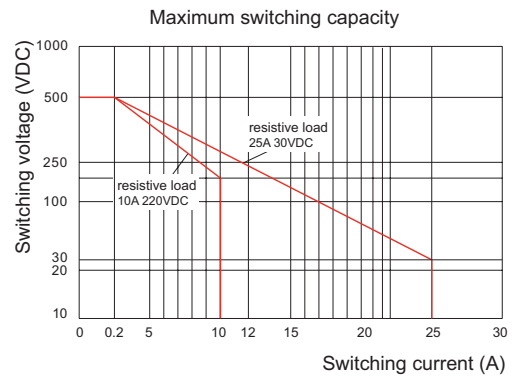
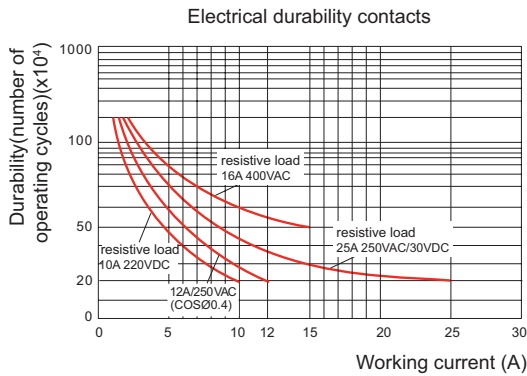

Dimensions (mm)

REH1AO/2AO/3AO

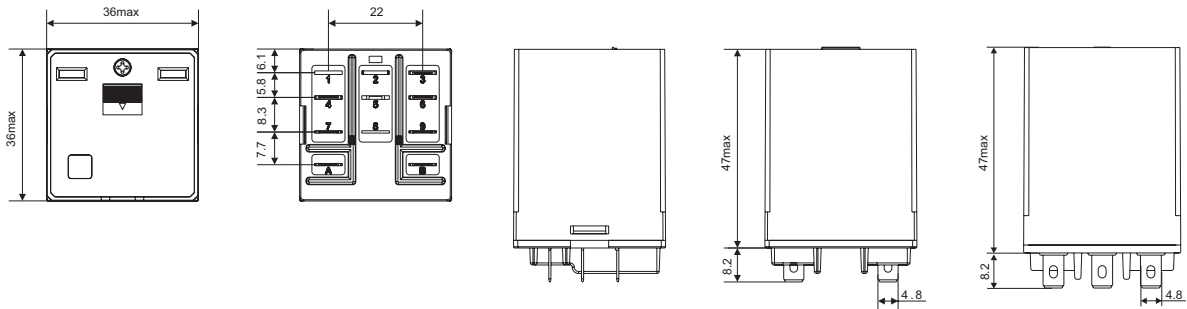

Wiring Diagrams

REH1AO

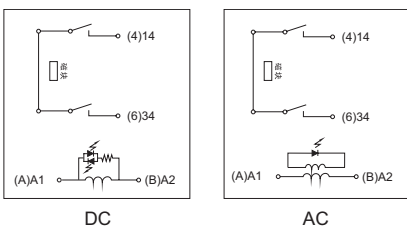

REH2AO

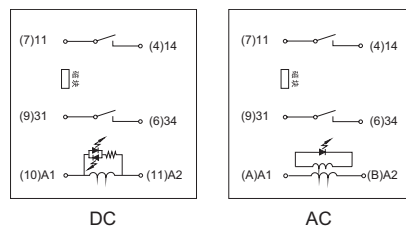

REH3AO

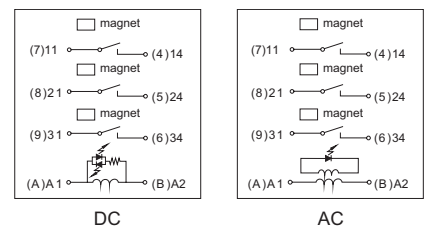

>>> REH Magnetic Blow-out Power Relay

REH Socket

>>> SEB11-E

Presentation



25 AMPS 500 VOLTS



Characteristics

Type		SEB11-E	
Nominal load	Current	A	25
	Voltage	V	500
Dielectric strength	Between coil and contact	V/min	4000
	Between contacts	V/min	2500
Max. tightening torque	Nm	1.2	
Wire size	AWG/mm ²	20-12/0.5-3.3	
Ambient temperature	°C	-40~+85	
Unit weight	g	64	

Relay, accessories selection table

Socket	Plastic clip	Metal clip	ID tag	Module	DIN rail
SEB11-E	-	SE52M	-	BMD	PFP

Dimensions (mm)

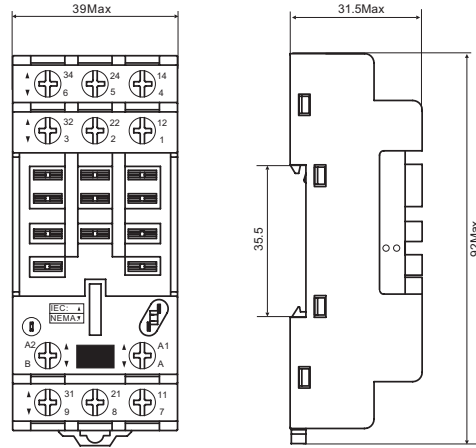

Connection Diagrams

- Ⓐ Ⓑ : A1 A2
- ① ② ③ : NC
- ④ ⑤ ⑥ : NO
- ⑦ ⑧ ⑨ : COM

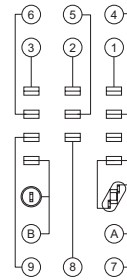

>>> SEB11-P

Presentation



15 AMPS 300 VOLTS



Characteristics

Type		SEB11-P	
Nominal load	Current	A	15
	Voltage	V	300
Dielectric strength	V/min	2500	
Ambient temperature	°C	-40~+85	
Unit weight	g	8.4	

Relay, accessories selection table

Socket	Plastic clip	Metal clip	ID tag	Module	DIN rail
SEB11-P	-	SE48M	-	-	-

Dimensions (mm)

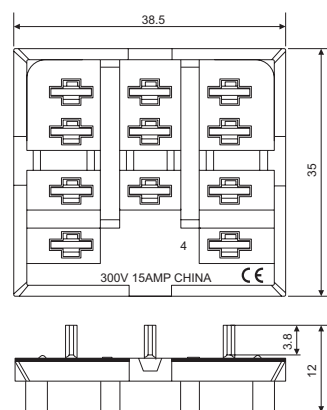

Connection Diagrams

- Ⓐ Ⓑ : A1 A2
- ① ② ③ : NC
- ④ ⑤ ⑥ : NO
- ⑦ ⑧ ⑨ : COM

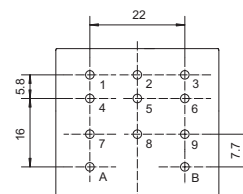

>>> RUB General Purpose Relay

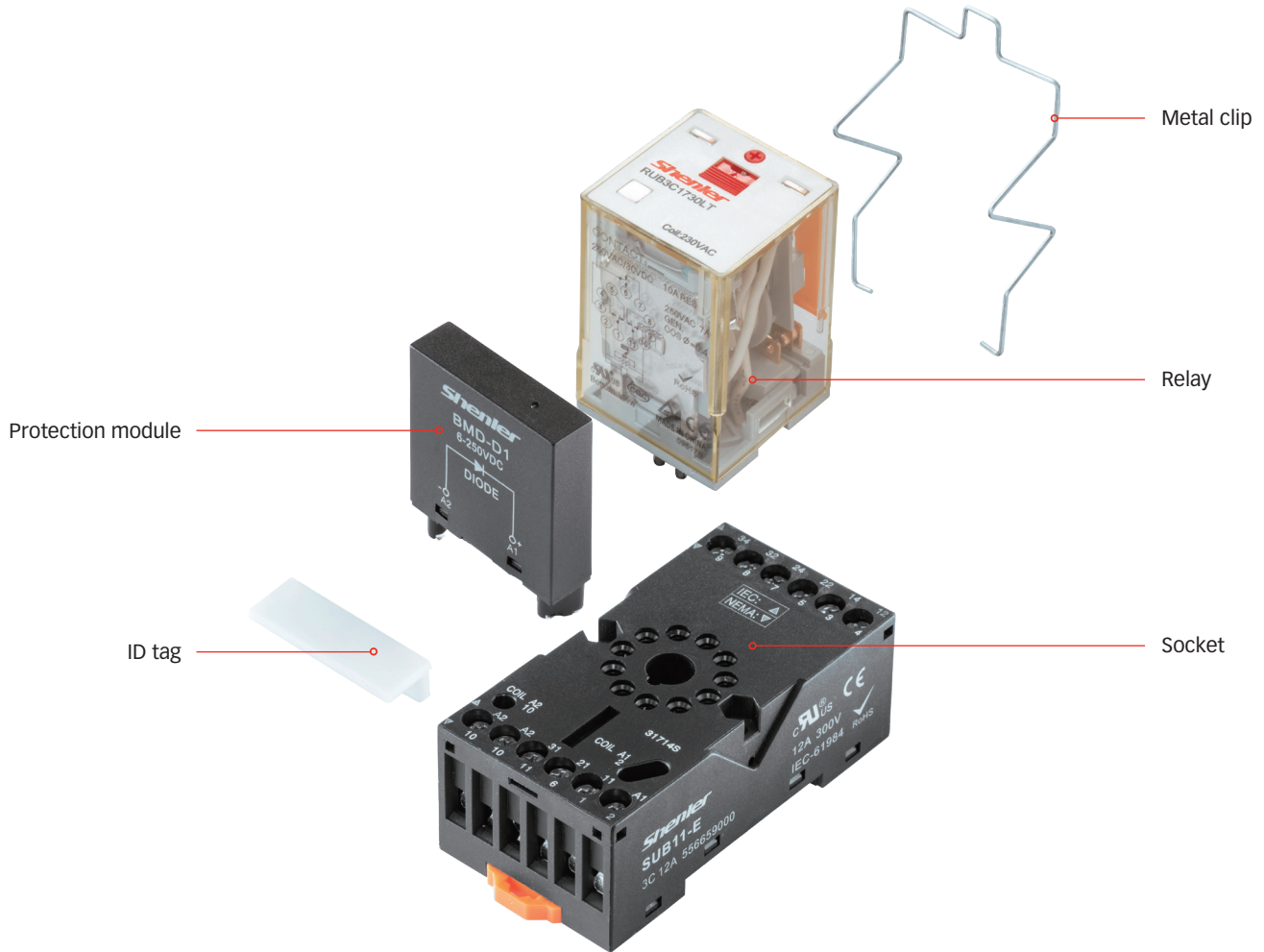

>>> Other applicable sockets selection table



SUB□□-A

Note: Applicable protection modules and accessories please refer to Page 71 to 73.

>>> RUB General Purpose Relay

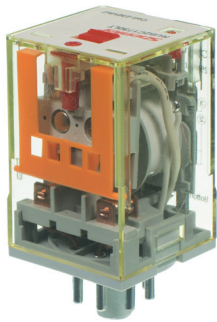

RUB2C

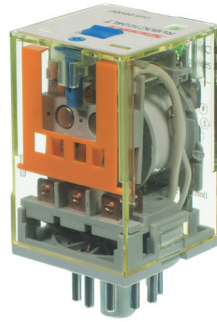

RUB3C



Features

- > 2 pole 3 pole contact load 10A
- > With non-polarity LED integrated in relay
- > With lockable test button and inspection window
- > Identification of coils through test button color (AC red/DC blue)
- > Conformity with RoHS Directive

Ordering Information

RUB

Contact form _____
 2C: 2CO
 3C: 3CO

Wiring type _____
 1: 1
 2: 2-1
 5: 5-1 (3C only)

Coil voltage code _____

Code	006	012	024	036	048	110	220	
Voltage (V DC)	6	12	24	36	48	110	220	
Code	506	512	524	536	548	615	730	740
Voltage (V AC)	6	12	24	36	48	115	230	240

Options

- LT: LED + test button
 LTD: LED + test button + diode
 RUB2C1 (2-,7+); RUB2C2 (1-,8+); RUB3C1 (2-,10+);
 RUB3C5 (2-10+); RUB3C2 (1-,11+)
 LTD1: LED + Test button + diode
 RUB2C1 (2+,7-); RUB2C2 (1+,8-); RUB3C1 (2+,10-);
 RUB3C5 (2+,10-); RUB3C2 (1+,11-)

Characteristics

	Configuration	2C	3C
Contact	Rated current/Rated voltage	10A/250VAC 30VDC (resistive RES); 7A/250VAC 30VDC (perceptual GEN)	
	Switching capacity (resistive)	2500VA, 300W	
	Initial contact resistance	≤50mΩ	
	Material	Ag alloy	
	Electrical durability	≥10 ⁵ (1800 ops/h)	
	Mechanical durability	≥2000 x 10 ⁴ (18000 ops)	
Pick-up voltage (23°C)		≤80%	
Drop-out voltage (23°C)		DC: ≥10%, AC: ≥30% 50/60Hz (Rated voltage)	
Maximum voltage (23°C)		110% (Rated voltage)	
Insulation resistance		≥100MΩ (500VDC)	
Coil operating power	DC(W)	approx. 1.5	
	AC(VA)	approx. 2.7	
Operate time (at nominal voltage)		≤30 ms	
Release time (at nominal voltage)		≤20 ms	
Initial breakdown voltage	Between open contacts	1000VAC/1min (leakage current 1mA)	
	Between poles	2500VAC/1min (leakage current 1mA)	
	Between contacts and coil	2500VAC/1min (leakage current 1mA)	
Ambient temperature		-10~+55°C	
Humidity		35%~85%RH	
Air pressure		86~106KPa	
Shock resistance		10G (half-sine shock pulse: 11ms)	
Vibration resistance		10~55Hz double-amplitude:1.5mm	
Mounting		Plug in	
Unit weight		approx. 85g	

Coil Specifications (23°C)

Nominal voltage V.DC	6	12	24	36	48	110	220	
Coil resistance Ω	23.7	96	430	860	1640	7360	29500	
Nominal voltage V.AC	6	12	24	36	48	115	230	240
Coil resistance Ω	3.9	17	62.5	144	305	1250	5900	6500

Remarks: Coil resistances under 10000Ω are measured with tolerances of ±10%Ω; above coil resistances 10000Ω are measured with tolerances of ±15%Ω.

Contact Specification

RUB2CO/3CO

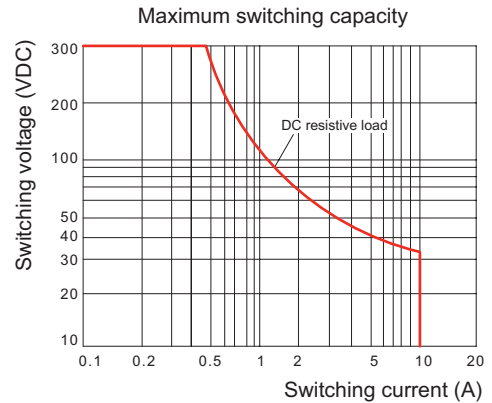
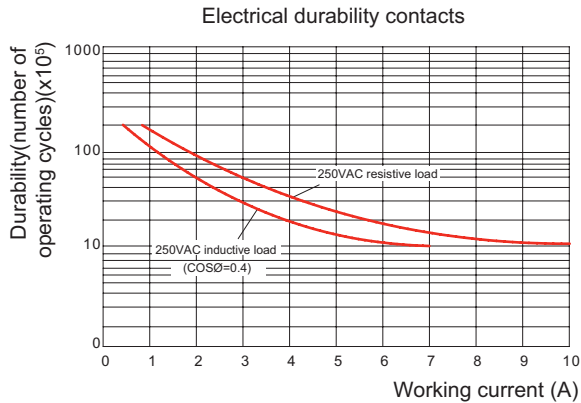

Dimensions (mm)

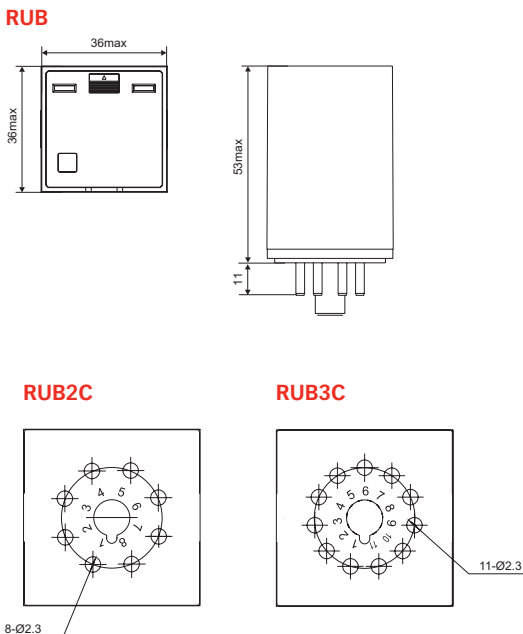

Wiring Diagrams

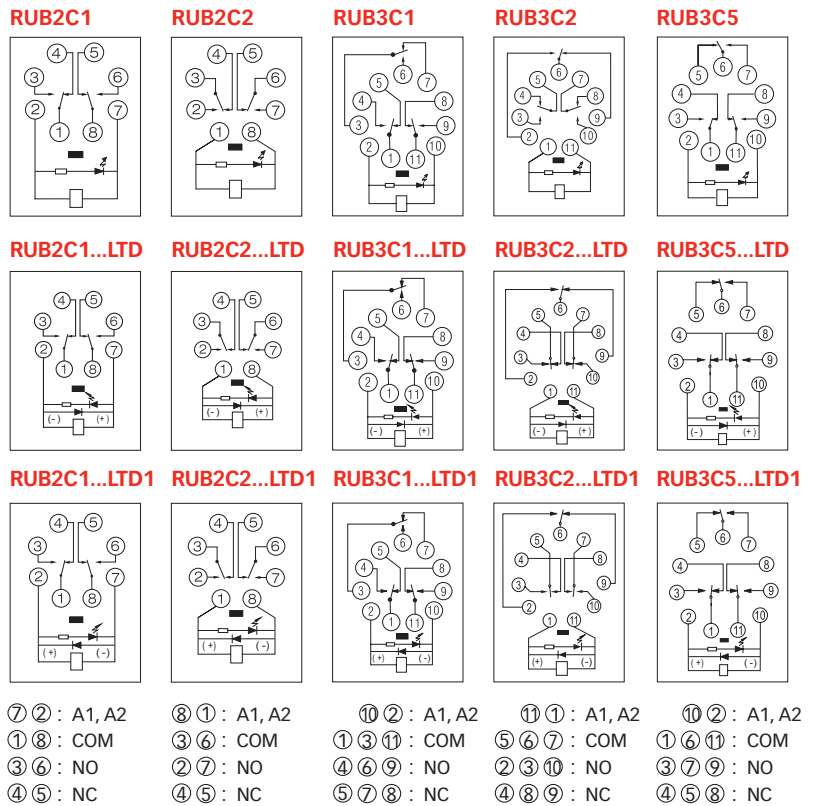

>>> RUB General Purpose Relay

RUB Socket

>>> SUB□□-E

Presentation



12 AMPS 300 VOLTS



Characteristics

Type			SUB08-E	SUB11-E
Nominal load	Current	A	12	
	Voltage	V	300	
Dielectric strength	V/min		2500	
Max. tightening torque	Nm		1.0	
Wire size	AWG/mm ²		20-14/0.5-2.5	
Ambient temperature	°C		-40~+85	
Unit weight	g		50	55

Relay, accessories selection table

Socket	Plastic clip	Metal clip	ID tag	Module	DIN rail
SUB08-E	-	SU60M	SU3P	BMD	PFP
SUB11-E	-	SU60M	SU3P	BMD	PFP

Dimensions (mm)

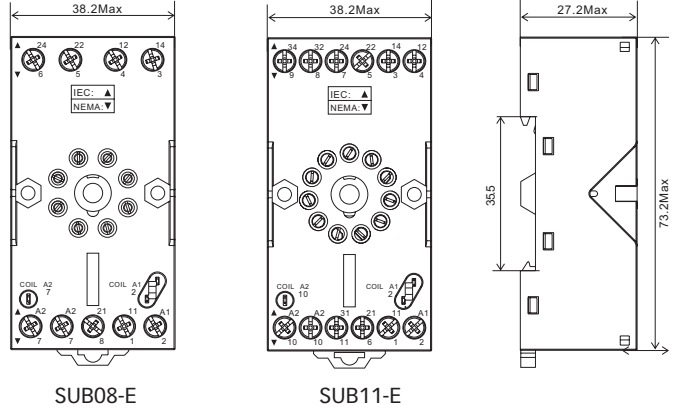

Connection Diagrams

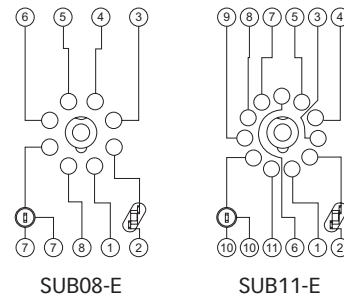

>>> SUB□□-A

Presentation

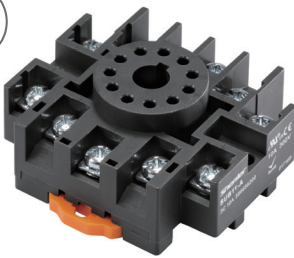

15 AMPS 300 VOLTS



Characteristics

Type			SUB08-A	SUB11-A
Nominal load	Current	A	12	10
	Voltage	V	300	
Dielectric strength	V/min		2500	
Max. tightening torque	Nm		1.0	
Wire size	AWG/mm ²		20-14/0.5-2.5	
Ambient temperature	°C		-40~+85	
Unit weight	g		37	50

Relay, accessories selection table

Socket	Plastic clip	Metal clip	ID tag	Module	DIN rail
SUB08-A	-	-	-	-	PFP
SUB11-A	-	-	-	-	PFP

Dimensions (mm)

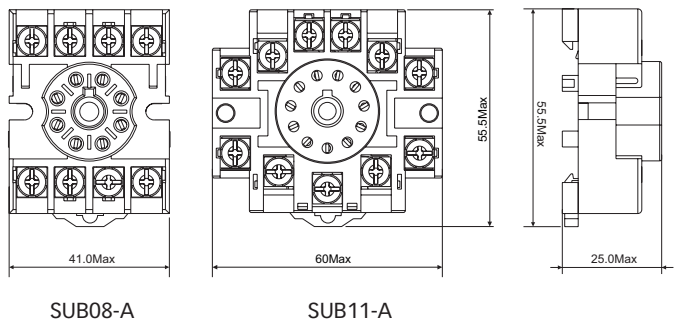

Connection Diagrams

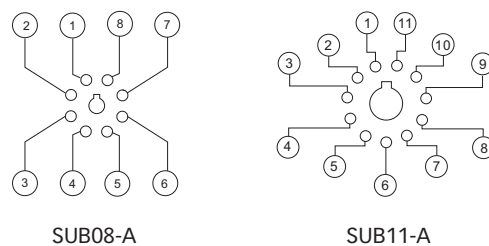

>>> RGF Power Relay



RGF2BU

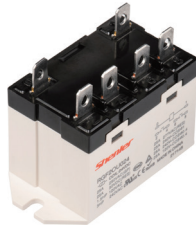

RGF2OU



RGF2BD



RGF2O



Features

- > 1 pole 30A ; 2 pole 25A/40A
- > Top-mounted 1/4" quick-connect terminals
- > Locating slot for DIN rail mounting
- > With finger protection cover
- > Conformity with RoHS directive
- > With safety module monitor

Ordering Information

RGF

Contact form _____

1: 1A (NO)
2: 2A (NO)

Mount options _____

O: plug in OD: plug in & DIN rail
OU: plug in & flange OK: plug in & clip
P: PCB BU: screw terminal & flange
BD: screw terminal & DIN rail

Coil voltage code _____

Code	006	012	024	048	110	220		
Voltage (V DC)	6	12	24	48	110	220		
Code	506	512	524	548	615	740	880	900
Voltage (V AC)	6	12	24	48	100-120	200-240	380	400

- Options _____
- L: with LED (only for BU and BD type)
F: with auxiliary module
S: with 40A/250VAC contact load (for 2 pole only)

Characteristics

		1A	2A	2A-S	
Contact	Configuration	1A	2A	2A-S	
	Rated current/ Resistive load	30A 277VAC/30VDC	25A 277VAC/30VDC	40A 250VAC/30VDC	
	Rated voltage Motor load	1.5HP, 120VAC; 3HP, 240VAC			
	Switching capacity (resistive)	8310VA, 900W	6925VA, 750W	10000VA, 1200W	
	Initial contact resistance	≤50mΩ			
	Auxiliary module	Configuration	1CO		
		Load (Resistive)	250VAC, 3A		
		Switching capacity (resistive)	750VA		
		Contact resistance	≤50mΩ		
	Material	Ag alloy			
Electrical durability	≥10 ⁵ (1800 Ops/h)		≥5 x 10 ⁴ (360 Ops/h)		
Mechanical durability	≥5000 x 10 ⁴ (18000 Ops/h)				
Pick-up voltage (23°C)	DC: ≤80% (Rated voltage), AC: ≤80% 50/60Hz (Rated voltage)				
Drop-out voltage (23°C)	DC: ≥15% (Rated voltage), AC: ≥15% 50/60Hz (Rated voltage)				
Maximum voltage (23°C)	110% (Rated voltage)				
Insulation resistance	≥1000MΩ (500VDC)				
Coil operating power	DC(W)	approx. 1.9			
	AC(VA)	approx. 2.5			
Operate time (at nominal voltage)	≤30 ms				
Release time (at nominal voltage)	≤30 ms				
Initial breakdown voltage	Between open contacts	2000VAC/1min (leakage current 1mA)			
	Between poles	2000VAC/1min (leakage current 1mA)			
	Between contacts and coil	4000VAC/1min (leakage current 1mA)			
Ambient temperature	-25~+55°C				
Humidity	35%~85%RH				
Air pressure	86~106KPa				
Shock resistance	10G (half-sine shock pulse: 11ms)				
Vibration resistance	10~55Hz double-amplitude:1.5 mm				
Mounting	plug in type; screw type; PCB type; DIN rail mounting type				
Unit weight	plug in type about 90g; screw type around 120g; screw type +DIN rail mounting with auxiliary module about 135g				

>>> RGF Power Relay

Coil Specifications (23°C)

Nominal voltage V.DC	6	12	24	48	110	220		
Coil resistance Ω	18.9	75	303	1220	6360	25474		
Nominal voltage V.AC	6	12	24	48	100-120	200-240	380	400
Coil resistance Ω	14	55	275	1100	5200	21000	62650	62650

Remarks: Coil resistances under 10000Ω are measured with tolerances of ± 10%Ω; above coil resistances 10000Ω are measured with tolerances of ± 15%Ω.

Contact Specification

RGF

Electrical durability contacts

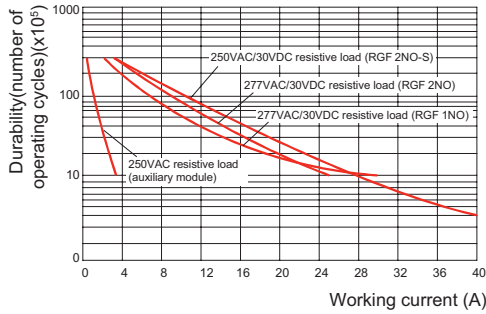

Maximum switching capacity

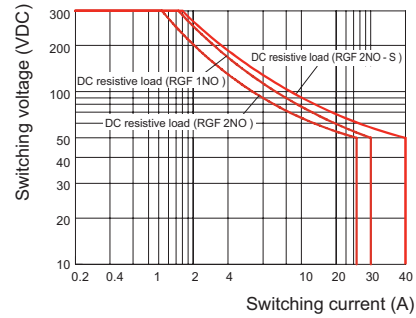

Dimensions (mm)

RGF1P/2P

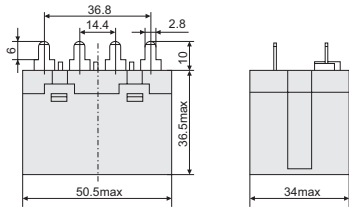

RGF1BU/2BU

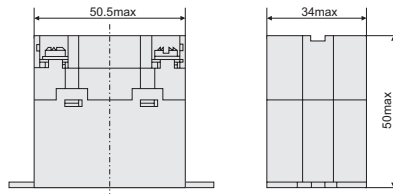

RGF10D/20D

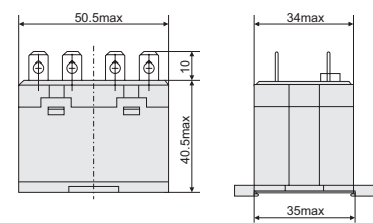

RGF10U/20U

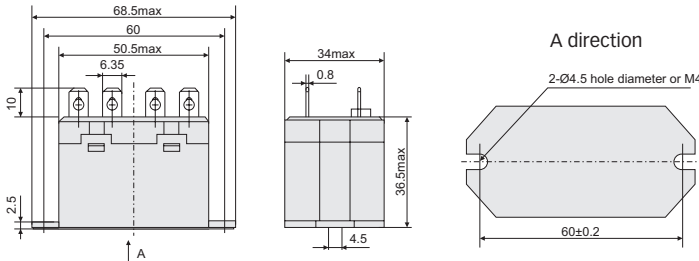

RGF1BD/2BD

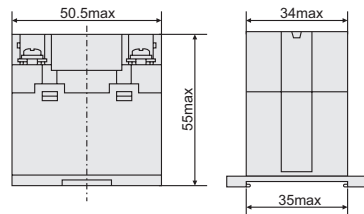

RGF10K/20K

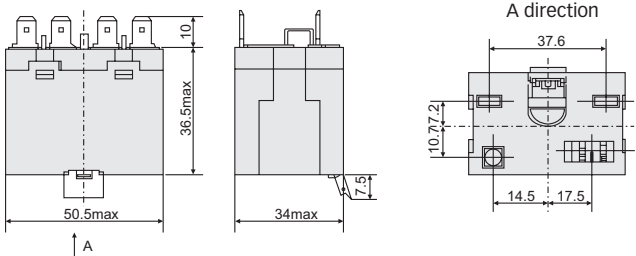

RGF2BD-F

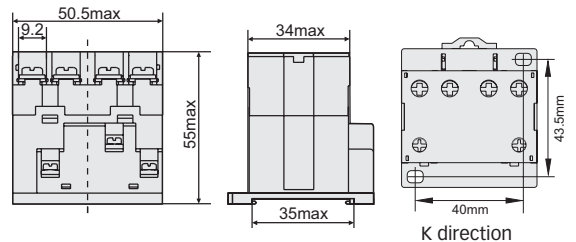

Note: Installation hole dimension.

Wiring Diagrams

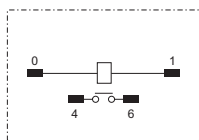

RGF1

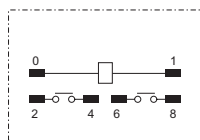

RGF2

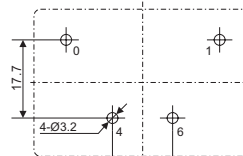

RGF1P

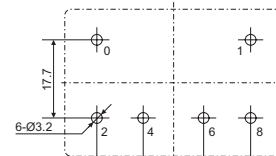

RGF2P



Note: RGF2BD-F, when relay in release condition, the auxiliary module is in NC position, when relay in pick up condition, the auxiliary module is in NO position.

>>> R2G Power Relay

Shenler
>>> Industrial Relay Series

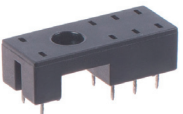

>>> Other applicable sockets selection table

			
SRC□□-ST	SRC□□-P	SRB□□-E	SRC□□-E

Note: Applicable protection modules and accessories please refer to Page 71 to 73.

>>> R2G Power Relay



Features

- > Available for 1 and 2 pole , a variety of high capacity models
- > High sensitive of consumed power 400mW
- > With up to 8mm of insulation distance between coil and contacts
- > High insulation with 10kv of shock resistant voltage
- > Meet with the ambient temperature 85°C

Ordering Information

R2G

Contact form _____
 1, 2 (A: NO, B: NC, C: CO)

Terminal arrangement _____
 O: 3.5mm contact pin pitch 1 pole 12A
 U: 5.0mm contact pin pitch 1 pole 12A
 H: 5.0mm contact pin pitch 1 pole 16A, 2 pole 8A

Coil voltage code _____

Code	005	006	009	012	024	048	060	110
Voltage (V DC)	5	6	9	12	24	48	60	110
Code	524	615	730					
Voltage (V AC)	24	115	239					

Material Level _____
 None: B class
 F: F class

Coil Consumption _____
 None: Standard (400mW)
 T: Sensitive (250mW)

Encapsulation Way _____
 S: Flux proof
 None: Sealed

Characteristics

	Configuration	1C/1A	2C/2A	
Contcat	Load	Resistive load (AC-1) Motor load (AC-15)	12A, 16A/250VAC, 30VDC 1/2HP, 240VAC; 3/4HP, 120VAC	
	Switching capacity (resistive)	3000VA, 360W; 4000VA, 480W	8A/250VAC, 30VDC 1/3HP, 240VAC; 1/4HP, 120VAC	
	Initial contact resistance	≤100mΩ	2000VA, 240W	
	Material	Ag alloy		
	Electric durability (110% rated voltage , 85°C)	3.5mm: 1NO 12A; 1NC 6A ≥10 ⁵ times (85°C)	5.0mm: 2NO 8A; 2NC 4A ≥10 ⁵ times (85°C)	
		5.0mm: 1NO 16A; 1NC 8A ≥10 ⁵ times (85°C)	-	
	Durability (Normal temperature)	3.5mm: 1NO 12A; 1NC 12A ≥5x10 ⁴ times (23°C)	5.0mm: 2NO 8A; 2NC 8A ≥5x10 ⁴ times (23°C)	
		5.0mm: 1NO 16A; 1NC 16A ≥3x10 ⁴ times (23°C)	-	
	Mechanical durability	DC≥5000x10 ⁴ times (18000 Ops/h); AC≥3000x10 ⁴ times (18000 Ops/h)		
	Pick-up voltage (23°C)	DC≤70% (Rated voltage)		
Drop-out voltage (23°C)	DC≥10% (Rated voltage)			
Maximum voltage (23°C)	130% (Rated voltage)			
Insulation resistance	≥1000MΩ (500VDC)			
Coil operating power	DC (W)	0.43		
	AC (VA)	1		
Operate time (at nominal voltage)	≤10 ms			
Release time (at nominal voltage)	≤5 ms			
Coil operating power	Between open contacts	1000VAC/1min (leakage current 1mA)	1000VAC/1min (leakage current 1mA)	
	Between poles	-	2500VAC/1min (leakage current 1mA)	
	Between contacts and coil	5000VAC/1min (leakage current 1mA)	5000VAC/1min (leakage current 1mA)	
Ambient temperature	-40~+85°C			
Humidity	5%~85%RH			
Air pressure	86~106KPa			
Shock resistance	10G (half-sine shock pulse: 11ms)			
Vibration resistance	10~55Hz double-amplitude: 1.5mm			
Mounting	PCB			
Unit weight	Approx. 13g			

Coil Specifications (23°C)

Nominal voltage V.DC	5	6	9	12	24	48	60	110
Coil resistance Ω	62.5	90	200	360	1440	5220	8570	28800
Nominal voltage V.AC	24	115	230					
Coil resistance Ω	350	8100	23800					

Remark: Coil resistance under coil voltage <5000Ω are measured with tolerance of ± 10%Ω, above coil voltage ≥5000Ω are measured with tolerance of ± 15%Ω.

Contact Specification

R2G-1

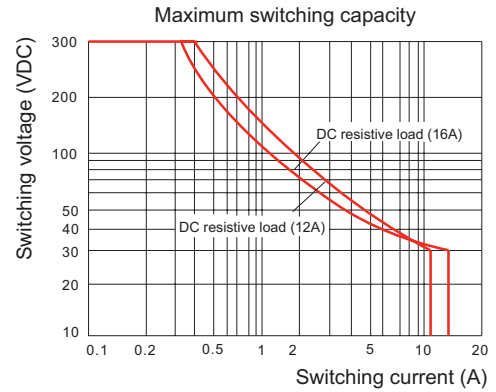
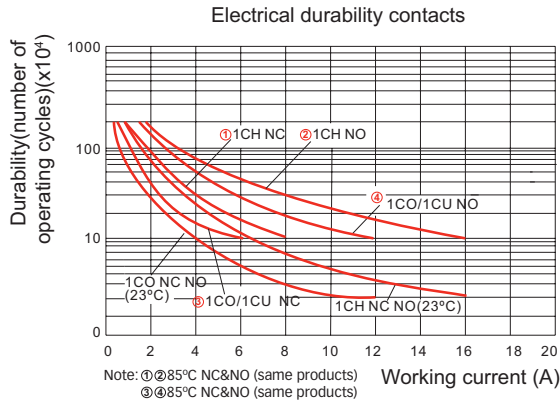

R2G-2

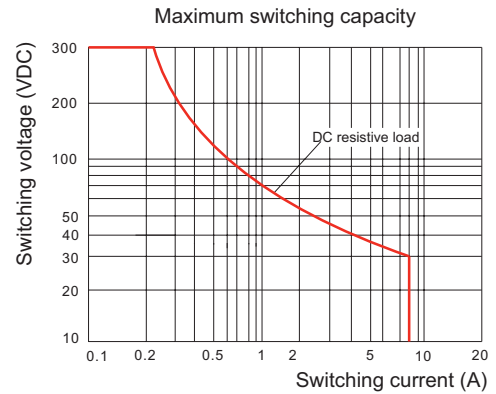
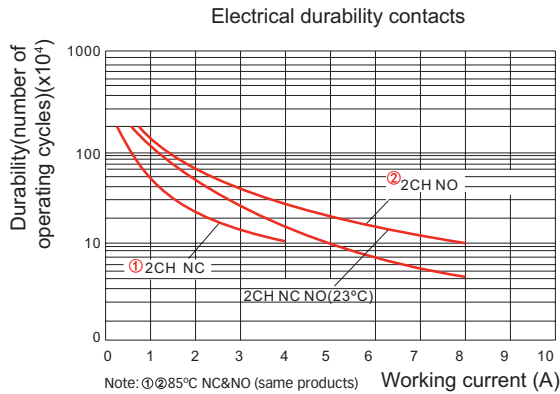

>>> R2G Power Relay

Dimensions (mm)

R2G1CO 3.5mm

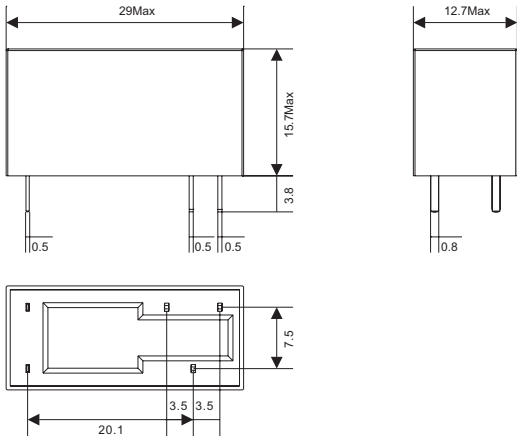

R2G1CU 5.0mm

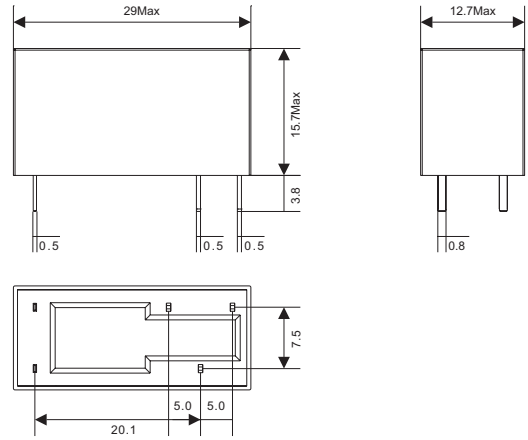

R2G1CH 5.0mm

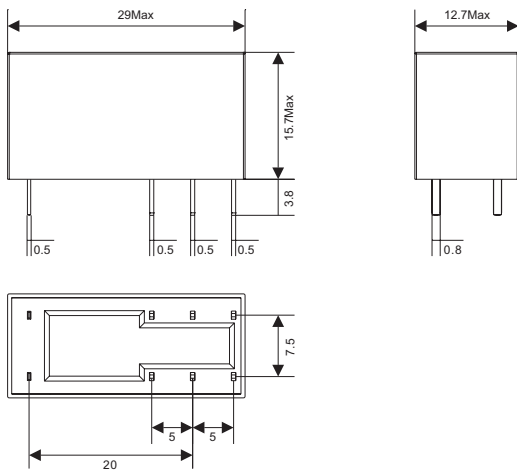

R2G2CH 5.0mm

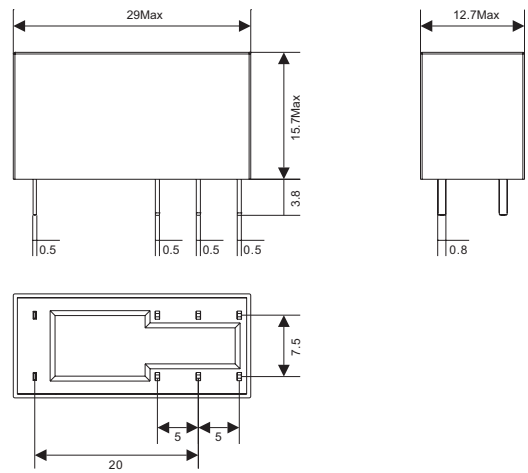

Wiring Diagrams

R2G1AO/1AU



R2G1AH



R2G1BO/1BU

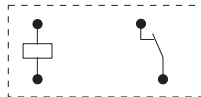

R2G1BH



R2G1CO/1CU



R2G1CH

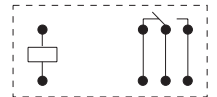

R2G2AH



R2G2BH



R2G2CH

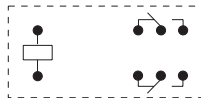

R2G Socket

▶▶ **SRC□□-ST**

Presentation



New



16 AMPS 300VOLTS



Relay vs Clip selection table	
Relay H (mm)	Clip Type
15	SR15L
20	SR20F
25	SR25C

Characteristics

Type	SRC05-ST		SRC08-ST	
Nominal load	Current	A	16	10
	Voltage	V	300	
Dielectric strength	Between coil and contact	V/min	4000	
	Between contacts	V/min	2500	
Max. tightening torque	Nm	-		
Wire size	AWG/mm ²	20-14/0.5-2.5		
Ambient temperature	°C	-40~+85		
Unit weight	g	37	42	

Relay accessories selection table

Socket	Plastic clip	Metal clip	ID tag	Module	DIN rail	Bus Jumper
SRC05-ST	SR20T	-	SR2P	AMD	PFP	ST01CC
SRC08-ST						

▶▶ **SRC□□-P**

Presentation



12 AMPS 300VOLTS



Characteristics

Type	SRC05-P		SRC08-P	
Nominal load	Current	A	12	8
	Voltage	V	300	
Dielectric strength	Between coil and contact	V/min	4000	
	Between contacts	V/min	2500	
Max. tightening torque	Nm	-		
Wire size	AWG/mm ²	-		
Ambient temperature	°C	-40~+85		
Unit weight	g	10	10	

Relay accessories selection table

Socket	Plastic clip	Metal clip	ID tag	Module	DIN rail
SRC05-P	-	SR15M	-	-	-
SRC08-P		SR1520M			

Dimensions (mm)

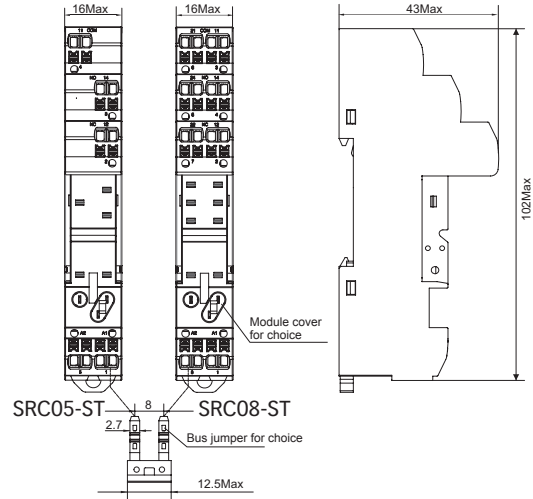

Connection Diagrams

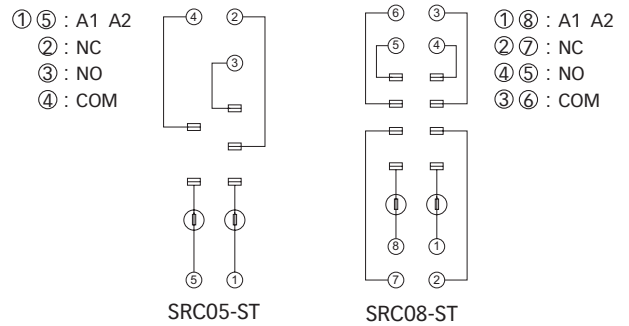

Dimensions (mm)

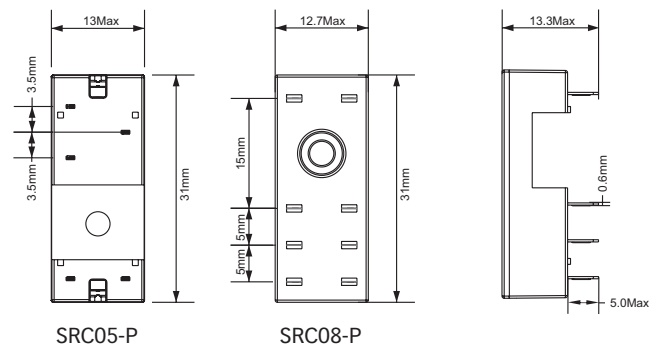

Connection Diagrams

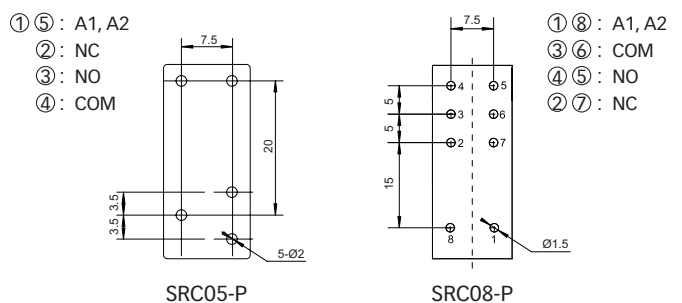

>>> R2G Power Relay

R2G Socket

>>> SRB□□-E

Presentation

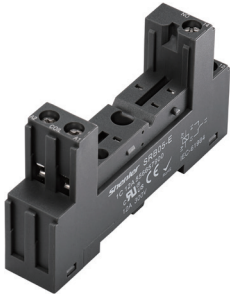

12 AMPS 300 VOLTS



Relay vs Clip selection table	
Relay H (mm)	Clip Type
15	SR15L
20	SR20F
25	SR25C

Characteristics

Type	SRB05-E	SRB08-E	
Nominal load	Current	A	12
	Voltage	V	300
Dielectric strength	Between coil and contact	V/min	4000
	Between contacts	V/min	2500
Max. tightening torque	Nm	1.0	
Wire size	AWG/mm ²	20-14/0.5-2.5	
Ambient temperature	°C	-40~+85	
Unit weight	g	33	37

Relay, accessories selection table

Socket	Plastic clip	Metal clip	ID tag	Module	DIN rail
SRB05-E	SR15L/20F/25C	-	SR2P	AMD	PPF
SRB08-E					

>>> SRC□□-E

Presentation



12 AMPS 300 VOLTS



Relay vs Clip selection table	
Relay H (mm)	Clip Type
15	SR15L
20	SR20F
25	SR25C

Characteristics

Type	SRC05-E	SRC08-E	
Nominal load	Current	A	12
	Voltage	V	300
Dielectric strength	Between coil and contact	V/min	4000
	Between contacts	V/min	2500
Max. tightening torque	Nm	1.0	
Wire size	AWG/mm ²	20-14/0.5-2.5	
Ambient temperature	°C	-40~+85	
Unit weight	g	33	37

Relay, accessories selection table

Socket	Plastic clip	Metal clip	ID tag	Module	Bus Jumper	DIN rail
SRC05-E	SR15L/20F/25C	-	SR2P	AMD	SR08B	PPF
SRC08-E						

Dimensions (mm)

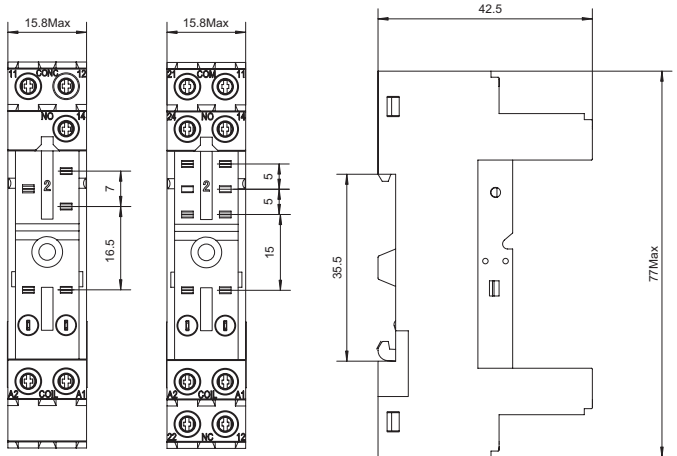

SRB05-E

SRB08-E

Connection Diagrams

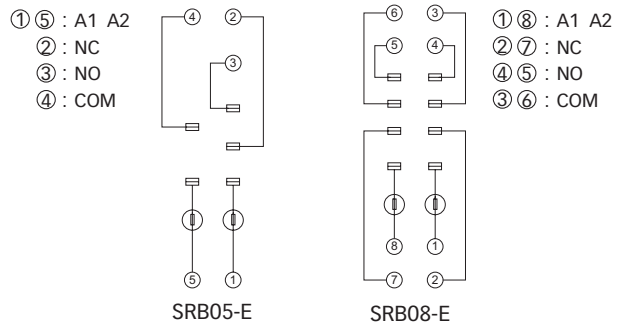

SRB05-E

SRB08-E

Dimensions (mm)

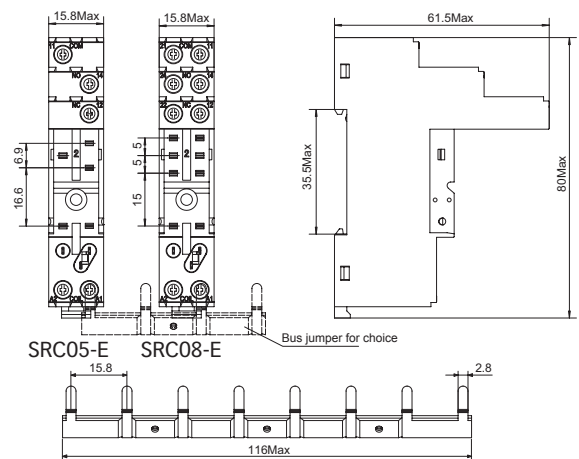

SRC05-E

SRC08-E

Connection Diagrams

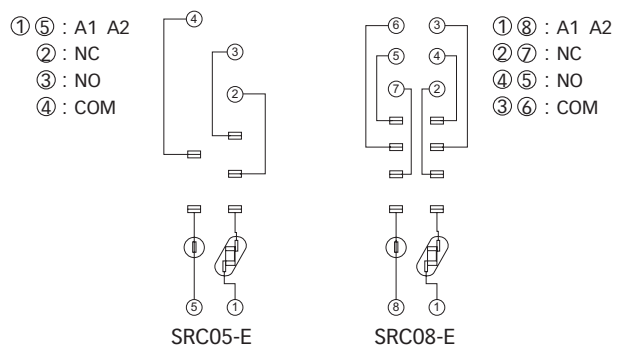

SRC05-E

SRC08-E



Features

- Built-in dedicated IC program control mini time relay
- > Reset time include midway reset time under 100ms
- > Use ⊖ screwdriver to set time
- > Meet IEC60947-5-1: 2016 (GB/T14048.5-2017)

Ordering information

TKB2B230A5S

Terminal Tyoe

- 2: 2CO
- 4: 4CO

Function

- B: On-delay
- E: Interval time-delay operation
- F: Repeat-cycle off time delay

Supply voltage

- 120A: 120VAC
- 230A: 230VAC
- 24D: 24VDC

Rated time

- 1s: 0.1s-1s
- 10s: 0.5s-10s
- 60s: 2.0s-60s
- 5min: 0.2min-5min
- 30min: 1min-30min
- 5s: 0.2s-5s
- 30s: 1s-30s
- 3min: 0.1min-3min
- 10min: 0.5min-10min

Specifications

Models	TKB2B	TKB4B
Rated supply voltage	120VAC, 230VAC 50/60Hz; DC24V	
Operating voltage range	Rated voltage 85-110% (90%-110% is DC12V)	
Power consumption	3.5W	
Max.output load	5A, 250 VAC (p.f.=1)	3A, 250 VAC (p.f.=1)
Min. output load	10 mA, 17 VDC	
Repetitive error	± 2% (FS max.)	
Setting error	± 5% (FS max.)	
Voltage error	± 2% (FS max.)	
Temperature error	± 2% (FS max.)	
Resetting time	Min.time: 0.2 sec	
Insulation resistance	100MΩ (DC500V)	
Dielectric strength	Between current-carrying and Non-current-carrying parts 2000V 50/60Hz min	
	Between control output terminals and operating circuit 1500V 50/60Hz min	
	Between contacts 1000V 50/60Hz min	
Vibration resistance	Destruction	10~55Hz with 0.75mm single amplitude each in 3directions for 2 hours each
	Malfubction	10~55Hz with 0.5mm single amplitude each in 3 directions for 10 minutes each
Shock resistance	Destruction	30G
	Malfubction	10G
Ambient temperature	-10°C~55°C	
Ambient humidity	35~85%RH	
Life expectancy	Mechanical	> 10 ⁷ (under no load, at 1,800 operations/hour)
	Electrical	> 10 ⁵
Weight	Approx. 60g	

>>> TKB Timer Relay

wiring diagram

TKB2B

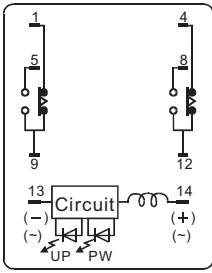

TKB4B

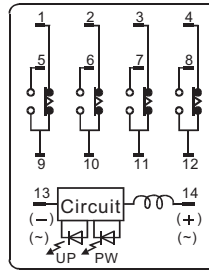

Timing charts

TKB2B

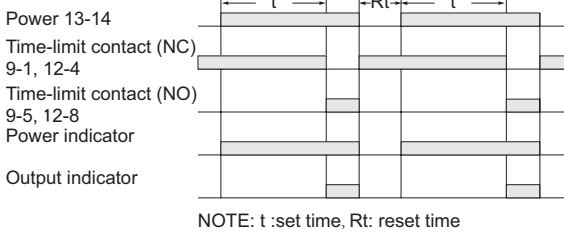

TKB4B

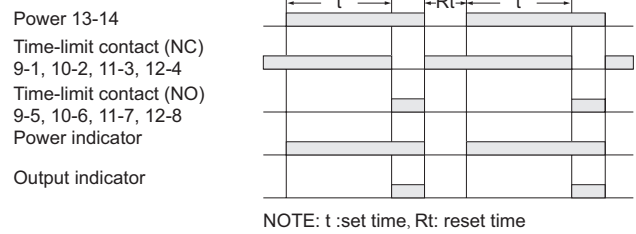

Dimensions

TKB □ □

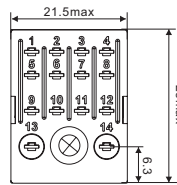
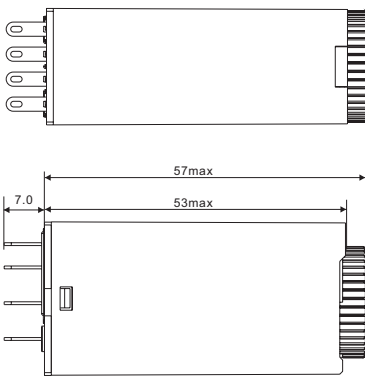

Socket Front

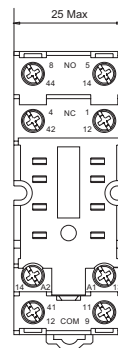

SKF08-E

Socket side

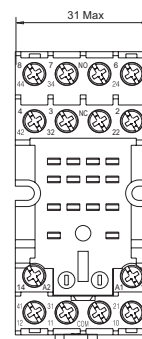

SKF14-E

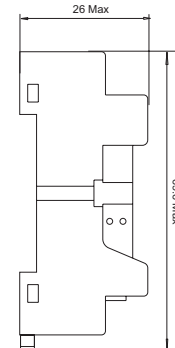



Features

- > Series version cover a wide range of rated times; 9.999 s, 99.99 s, 999.9 s, 99 min 59 s, and 99 hrs 59 min
- > Selection of elapsed time indication, remaining time indication, contact output, and transistor output types to suit requirements
- > Power supply freely selectable within a range of 100 to 240 VAC, as well as 12 to 48 VDC

Ordering informaton

TCN5Q171NA

Mounting type

5: Round 8-pin

Function

Q: Up display

Y: Down display

Rated voltage

171N: 100-240VAC

031N: 12-48VDC

Time delay range

A: 99.99S

B: 999.9S

C: 99m59s

D: 99h59m

Specifications

Type	TCN5Q□□	TCN5Y□□
Display type	UP Display	Down Display
Output type	Numeric display	
Timing function	Power ON-Delay	
Output mode	1 form delay output	
Terminal form	8-Pin	
Rated supply voltage	AC	100-240V, 50/60Hz
	DC	12-48V
Operating voltage range	85~ 110% of rated supply voltage	
Power consumption	AC	Approx.4W (AC 240V 50Hz)
	DC	Approx.4W (DC48V)
Control outputs	Time-delay	SPDT(1C)
	Max.load	5A, 250 VAC (p.f. =1)
	Min.load	10mA, 5 VDC
Repetitive error	} ± 0.01% ± 50ms	
Setting error		
Voltage error		
Temperature error		
Resetting method	Power-off, external and self-reset	
Resetting time	Max.0.5 sec	
Vibration resistance	Destruction	10~55Hz with 0.75mm single amplitude each in 3directions for 2 hours each
	Malfunction	10~55Hz with 0.5mm single amplitude each in 3 directions for 10 minutes each
Shock resistance	Destruction	20G
	Malfunction	10G
Insulation resistance	100MΩ min. (at 500VDC) between current-carrying terminal and exposed non-current carrying metal parts,between power supply circuit and control output circuit	
Dielectric strength	2000Vac,50/60Hz for 1min (Between current-carrying terminal and exposed non-currentcarrying metal parts,and between power contact and control circuit,1000VAC,50/60Hz for 1 min between noncontinuous contacts	
Life expectancy	Electrical life	> 10 ⁷ (under no load, at 1,800 operations/hour)
	Mechanical life	> 10 ⁵ (AC 250V, 5A)
Weight	Approx.200g	

>>> TCN Digital Timer

Connection Diagram

TCN5□□□

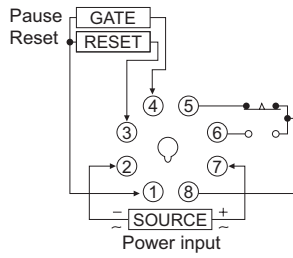

Timing Charts

Up display

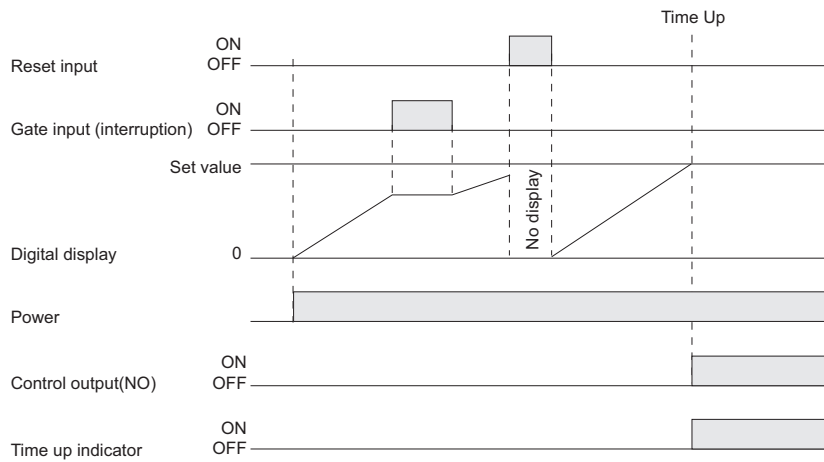

Down display

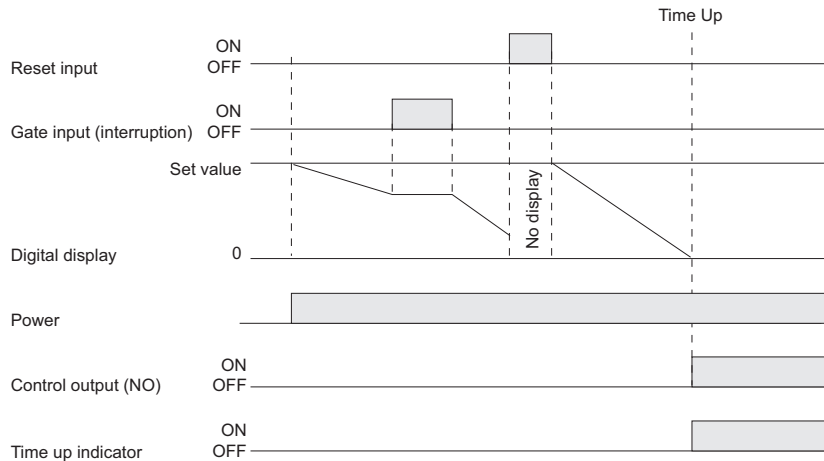

Dimensions

Unit: mm

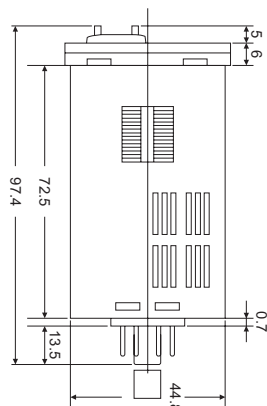
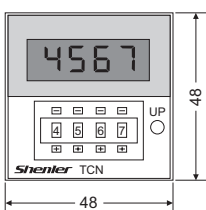

Panel cutout

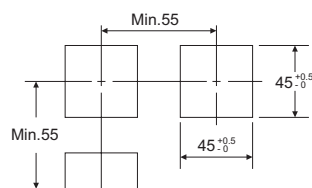

Note: Recommended panel 1-3.2mm.

Socket Front

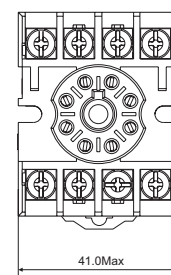

SUB08-A

Socket Side

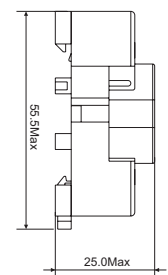



Features

- > A wide AC/DC power supply range greatly reduces the number of timer models kept in stock
- > A wide range of applications with multiple operating modes, 6 modes for 11-pin, models and 4 modes for 8-pin models
- > Easy sequence checking with instantaneous outputs for a zero set value

Model Number structure

TCR5BN171N

Number of pins

5: 8-pin models

Input Type for 8 pins

BN: Power-up start Timer, DPCO multi-function multi-voltage. 8-pin

(A: ON-delay, B2: Flicker ON start, E: Interval, J: One-shot)

BK: Power-up start Timer, single voltage On-Delay with Instantaneous contact. 8-pin

HN: Power-up start Timer, Multi-voltage On-Delay with Instantaneous contact. 8-pin

Supply voltage

BN & HN:

171N: 100-240VAC 100-125VDC

037N: 24-48VAC 12-48VDC

BK:

110A: 110VAC

220A: 220VAC

024D: 24VDC

Ordering information

TCR6BM171N

Number of pins

6: 11-pin models

Input Type for 11 pins

BM: Signal start Timer, DPCO multi-function single voltage or multi-voltage 11-pin

(B: ON-delay, F: Flicker ON start,

R: Flicker OFF start, C: signal ON/OFF delay,

D: signal OFF delay, E: Interval)

Rated voltage

110A: 110VAC

220A: 220VAC

024D: 24VDC

171N: 100-240VAC 100-125VDC

037N: 24-48VAC 12-48VDC

Specifications

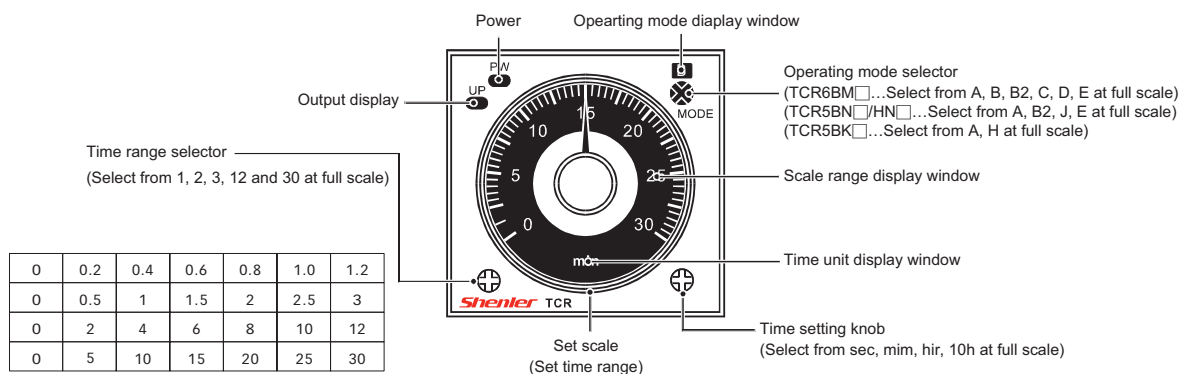

>>> TCR Solid-state Timer

Specifications

Models		TCR6BM□	TCR5BN□	TCR5HN□	TCR5BK□
Output control	Delay operation	SPDT(2C)		SPDT(1C)	A: 2SPDT (2C)
	Instantaneous			SPDT(1C)	H: signal ON/OFF delay
	Max.output load	5A, 250VAC(p.f.=1)			
	Min output load	10mA, 5VDC			
Operating voltage range		85~110% rated supply voltage			
Repetitive error		±0.3% (FS max.), (±0.3% 10ms max. in range of 1.2s)			
Setting error		±5% (FS max.) ±5ms			
Voltage error		±0.5% (FS max.) (±0.5% ±10ms max. in a range of 1.2s)			
Temperature error		±2% (FS max.) (±2% ±10ms max. in a range of 1.2s)			
Reset time		0.1sec			
Mounting method		DIN rail mounting, surface mounting			
Ambient temperature		-10°C ~55°C			
Ambient humidity		35~85%RH			
Insulation resistance		100MΩ (DC500V)			
Dielectric strength		2000V 50/60Hz min (between current-carrying metal parts and exposed non-current-carrying metal parts) 1500V 50/60Hz min(between control output terminals and operating circuit), not include DC12V 1000V 50/60Hz min Between contacts			
Static immunity		8KV (Malfunction), 15KV (Destruction)			
Impulse withstand voltage		3KV (between power terminals) 1KV for 24VDC 4.5KV (Between current-carrying terminal ans exposed non-current carrying metal parts) 1.5KV for 24vdc			
Vibration resistance	Destruction	10~55Hz with 0.75mm singal amplitude each in 3 directions for 2 hours each			
	Malfubction	10~55Hz with 0.5 mm singal amplitude each in 3 directions for 10 minutes each			
Shock resistance	Destruction	30G			
	Malfubction	10G			
Life expectancy	Mechanical	> 10 ⁷			
	Electrical	> 10 ⁵ (AC 250V, 3A)			
Protection grade		TEC: IP40			
Weight		Approx. 95g			

Connection Diagram

TCR6BM□

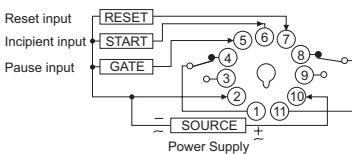

TCR5BN□

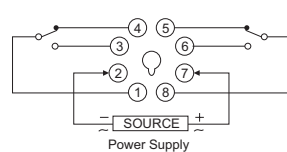

TCR5BK□

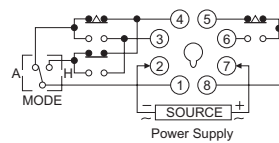

TCR5HN□

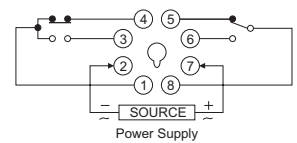

Dimensions

Unit: mm

TCR5HN□ TCR6BM171N
TCR5BN□ TCR6BM037N

TCR5BK□ TCR6BM110A
TCR6BM220A TCR6BM024D

Socket Front

Socket Side

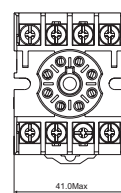
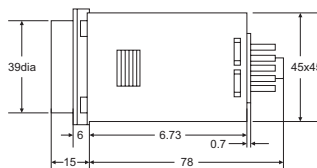
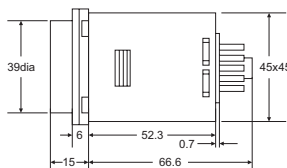
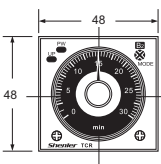

SUB08-A

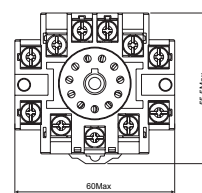

SUB11-A

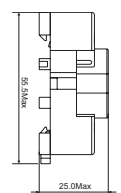

>>> TMC7-□ Solid-State Counter Shenler Timer Series



Features

- > In addition to UP and Down models, a reversible(Up-Down)counter is also available
- > Maximum counting speed of 1000cps, never before attained by a small-size preset counter. Models with memory backup function against power failure available
- > Power supply freely selectable within a range of 100 to 240VAC. Also, power supply for the DC-operated models is selectable within a range of 12 to 48 V

Ordering Information

TMC7 - Q L - 171N

Count models

Q: Up Count

Y: Down Count

Count Speed

L: 30 cps

H: 1k cps

Rated Voltage

171N: 100~240VAC

031N: 12~48VDC

Specifications

Models	TMC7-QL-□	TMC7-QH-□	TMC7-YL-□	TMC7-YH-□
Supply voltage	AC100~240V 50/60Hz, DC12~48V (contains 20% ripple Max.)			
Operating voltage range	85~110% of rated voltage			
Power consumption	Approx.4W (AC 240V 50Hz), 4W (DC48V)			
CP1, CP2 Max. counting speed	30 cps: (contact and transistor inputs) Min.pulse width:16.7 ms (ON/OFF ratio:1:1) 1K cps(transistor inputs) Min. pulse width:0.5 ms (ON/OFF ratio:1:1)			
Reset system	Power-OFF reset: Reset time 0.5s, Reset time following power application 0.05 s. External reset & manual reset: Rest time 0.02s, Reset time following signal application: 0.05 s.			
Signal input	Count and Reset			
Input methods	Contact Impedance by short-circuiting contacts:1kΩ Max. Residual viltage: 2V Max. Impedance by opening contacts :100 kΩmin			
Control output	5A 250VAC Cosφ=1 SPDT(1C)			
Operating mode	Up-counting		Down-counting	
Display	7-segment LEDs			
Ambient temperature	-10°C ~55°C			
Storage Ambient temperature	-25°C ~65°C			
Ambient humidity	35~85%RH			
Insulation resistance	100MΩ (DC500V)			
Dielectric strength	2000VAC, 50/60Hz for 1 min(between current-carring terminal and exposed non-current carrying mrtal parts and between no-continuous contacts)			
Static immunity	Malfunction 8kv			
Impulse withstand voltage	6kv(between power terminals) 6kv (between current-carrying terminal and exposed non-current-carrying metal parts)			
Vibration	Destruction		10~55Hz, 0.75mm single amplitude	
	Malfunction		10~55Hz, 0.5mm single amplitude	
Shock resistance	Destruction		20G	
	Malfunction		10G	
Life expectancy	Mechanical		10 million operations min.	
	Electrical		100,000 operations min.	
Protection grade	TEC:IP40(only for panel)			
Weight	Approx.200g			

>>> TMC7-□ Solid-State Counter

Terminal Arrangement

TMC7-□□□

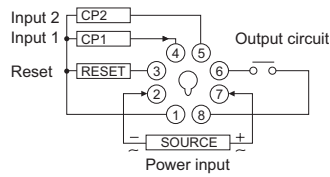

Up/Down Selectable Type

Input Mode

TMC7-Q□ Up mode

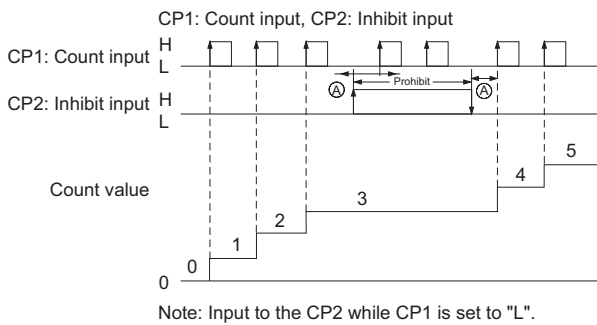

TMC7-Y□ Down mode

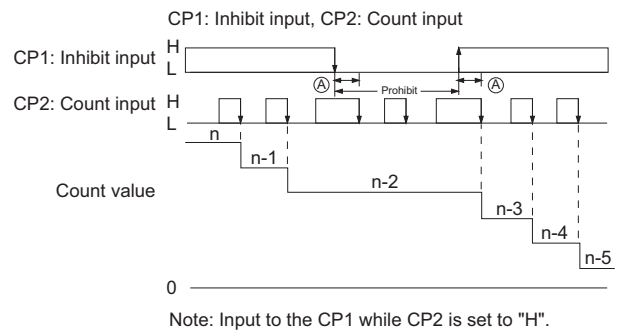
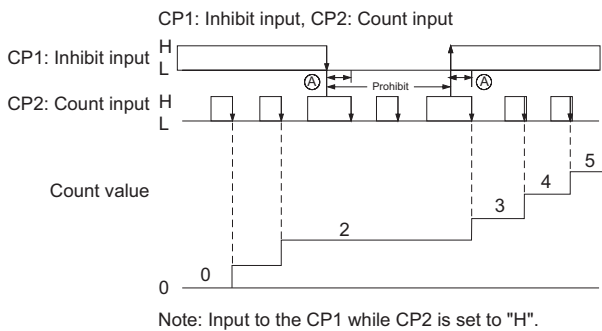
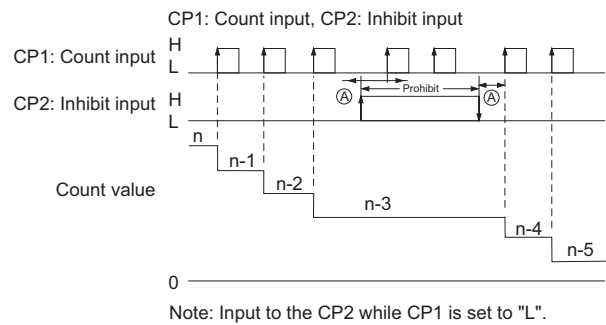

Up/Down Type

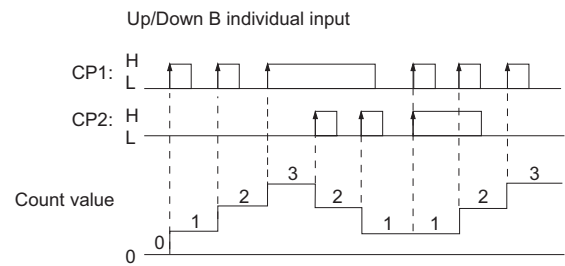
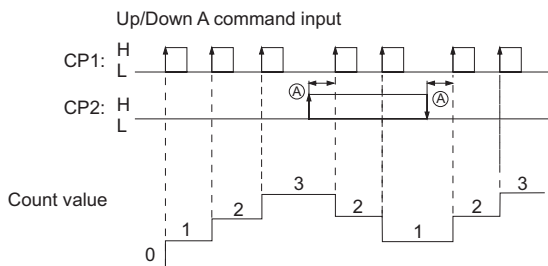

Note:A must be more than the minimum signal width. If (A) is set shorter than the minimum signal width, the error of count ± 1 may occur.
 H: Short-circuit ON-time impedance; 1k Ω max. Residual voltage 2v max.
 L: Open circuit OFF-time impedance; 100k Ω min.

Dimensions

Unit: mm

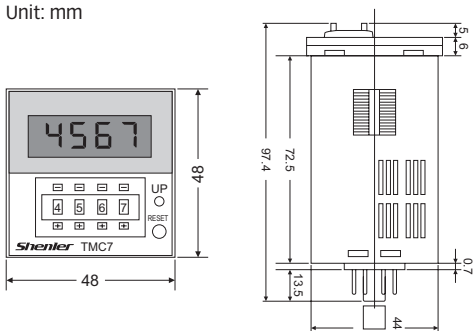

Panel cutout

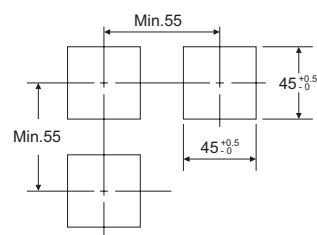

Note: The standard panel thickness is 1-3.2mm.

Socket Front Mounting

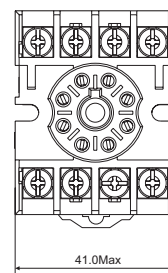

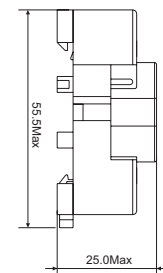

Socket Flush Mounting











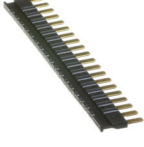

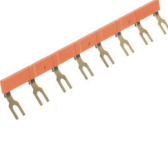

>>> Socket accessories

Shenler
Socket and Accessory Series

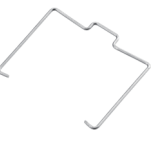
SK36F	SK28L	SR25C	SR20F	SR20T	SR15L
					
SKB/SKC series	SKB/SKC series	SRC/SRU series	SRC series	SRU series	SRC/SRB series

SN20S	SR2P	SK4P	SK2P	SU3P
				
SNC05-E/S	SRC/SRB series	SKC/SKB series	SKE/SKF series	SUB series

SN64P	SN20B	SR08B	SR08C	PFP	SY36S	SR15M
						
SNC05-E/S	SNC05-E/S	SRU05/08-E SRC05/08-E	SRT05/08-E/-A/-ES	DIN	SYF series	SRC05/08-P

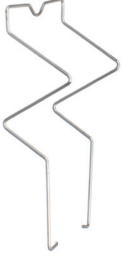
SR1520M	SR2025M	ST36M4C	ST36M3C	SK36M	SE48M	SE52M	SU60M
							
SRC05/08-P	SRC05/08-P	STB14-E	STB11-E	SKC/SKB/SKE/ SKF series	SEB11-P	SEB11-E	SUB series

>>> Socket accessories

AMD Module



Features

- > For surge suppressor
- > With LED
- > Work with relay socket

Ordering Information

Description

L : LED
 LDD: LED + diode
 RC: RC circuit
 ML: Varistor + LED
 M: Varistor
 D: diode

Polarity

blank : A1 -, A2 +
 1: A1 +, A2 -

Voltage

As per below schemes

AMD -

Dimensions and Schemes (mm)

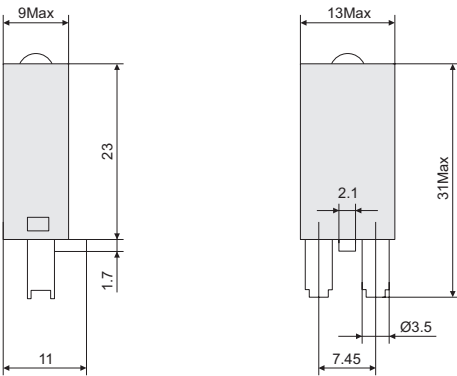

AMD-L 6-24VAC/DC	AMD-L1 6-24VAC/DC	AMD-L 110-240VAC/DC	AMD-L1 110-240VAC/DC	AMD-LDD 6-24VDC			
AC/DC circuit + LED	AC/DC circuit + LED	AC/DC circuit + LED	AC/DC circuit + LED	DC circuit + LED + Diode			
AMD-LDD1 6-24VDC	AMD-LDD 110V/240VDC	AMD-LDD1 110V/240VDC	AMD-D 6-250VDC	AMD-D1 6-250VDC	AMD-ML 24VAC/DC	AMD-ML1 24VAC/DC	AMD-ML 120VAC/DC
DC circuit + LED + Diode	DC circuit + LED + Diode	DC circuit + LED + Diode	DC circuit + Diode	DC circuit + Diode	AC/DC circuit + LED + Varistor	AC/DC circuit + LED + Varistor	AC/DC circuit + LED + Varistor
AMD-ML1 120VAC/DC	AMD-ML 240VAC/DC	AMD-ML1 240VAC/DC	AMD-RC 6-24VAC	AMD-RC 110V/240VAC	AMD-M 24VAC/DC	AMD-M 120VAC/DC	AMD-M 240VAC/DC
AC/DC circuit + LED + Varistor	AC/DC circuit + LED + Varistor	AC/DC circuit + LED + Varistor	AC circuit + RC	AC circuit + RC	AC/DC circuit + Varistor	AC/DC circuit + Varistor	AC/DC circuit + Varistor

BMD Module



Features

- > For surge suppressor
- > With LED
- > Work with relay socket

Ordering Information

Description

L : LED
LDD: LED + diode
RC: RC circuit

ML: Varistor + LED
M: Varistor
D: diode

Polarity

blank : A1 - , A2 +
1: A1 + , A2 -

Voltage

As per below schemes

BMD - □ □ □

Dimensions and Schemes (mm)

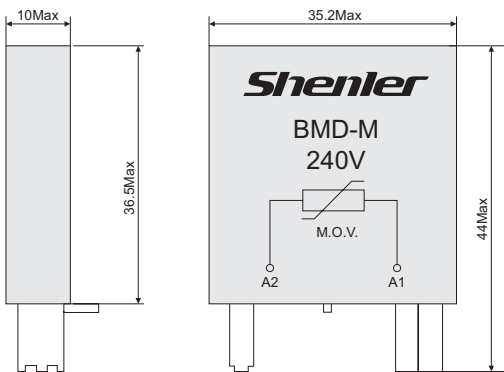

BMD-L 6-24VAC/DC		BMD-L1 6-24VAC/DC		BMD-L 110-240VAC/DC		BMD-L1 110-240VAC/DC		BMD-LDD 6-24VDC	
AC/DC circuit + LED		AC/DC circuit + LED		AC/DC circuit + LED		AC/DC circuit + LED		DC circuit + LED + Diode	
BMD-LDD1 6-24VDC		BMD-LDD 110V/240VDC		BMD-LDD1 110V/240VDC		BMD-D 6-250VDC		BMD-D1 6-250VDC	
DC circuit + LED + Diode		DC circuit + LED + Diode		DC circuit + LED + Diode		DC circuit + Diode		DC circuit + Diode	
BMD-ML1 120VAC/DC		BMD-ML 240VAC/DC		BMD-ML1 240VAC/DC		BMD-RC 6-24VAC		BMD-RC 110V/240VAC	
AC/DC circuit + LED + Varistor		AC/DC circuit + LED + Varistor		AC/DC circuit + LED + Varistor		AC circuit + RC		AC circuit + RC	
BMD-M 24VAC/DC		BMD-M 120VAC/DC		BMD-M 240VAC/DC		BMD-M 24VAC/DC		BMD-M 120VAC/DC	
AC/DC circuit + Varistor		AC/DC circuit + Varistor		AC/DC circuit + Varistor		AC/DC circuit + Varistor		AC/DC circuit + Varistor	

Shenler

SHENLE CORPORATION LTD.

Address: No.666 East Jiaotong Rd., Wu'niu St., Yongjia, Wenzhou,
Zhejiang, China

Post code: 325000

Tel: + 86-577-62994088/57150677/57150678/57150666

Fax: + 86-577-62985000/62981722

E-mail: sales@shenler.com

Website: www.shenler.com



The official Website: Shenle Relay

Note:

We reserve the right to make technical changes or modify the contents of this document without prior notice.

We reserve all rights in this document and in the subject matter and illustrations contained therein.

Any reproduction, disclosure to third parties or utilization of its contents – in whole or in parts is forbidden without prior written consent of Shenler.

Copyright © 2020 shenler electric (6)

All rights reserved.