

Data Book

Dear Partner,

Let us introduce ourselves.

Itelcond is an Italian company, with over 40 years of experience in the design and production of aluminium electrolytic capacitors.

Our production range covers any application where a high quality standard is required; therefore we address to industrial partner in the fields of UPS, Inverter, Solar, Wind, Automation, Railways, Welders, Control Motor, Medical Equipment.

We offer our partners the advantage of cooperating with a firm that produces exclusively in Italy, leader in those sectors where the joint design-in is the real added value to a project.

Please find the latest updates on our website

www.itelcond.it



Data Book	
Screw Terminal Series	4
Solder Pin Series	5
Electrical Characteristics	6
Capacitance	6
Equivalent Series Resistance	6
Dissipation Factor (DF)	7
Impedance (Z)	7
Superimposed Alternating Current (IRipple)	7
Voltage	8
Rated Voltage	8
Surge Voltage	8
Reverse Voltage	9
Expected Life	9
Marking	9
Capacitance Tolerance	9
Leakage Current (If)	9
Outgoing Leakage Current	10
Operating Leakage Current	10
Leakage Current Multipliers	10
Leakage Current decrease Vs Voltage Derating	10
Leakage Current at Voltage-free storage	11
Storage Temperature	11
Shelf Life	11
IEC Climatic Category	11
Reliability	12
Operational Life	12
Confidence Level	14
Assessed Failure Rate	14
Failure Rate (λ)	14
Failure in Time (FIT)	14
Typical FIT Values	15
Mean Time Between Failure (MTBF)	15
Test	16
Shelf Test	16
Surge Voltage Test	16
Vibration Test	16
Screw Terminals	16
Solder Pins	16
Sealing Test	16
Low Pressure	16
Lifetest	17

Lifetest Procedures	17
Electrical Parameters Change	17
Operational Lifetime and Voltage Derating	18
Useful Life Calculation	19
Capacitor Connection	21
Insulation Strenght	21
Self Recharging(Dielectric Absorption)	21
Cleaning Agents	22
Databook Ordering Code	22
Packaging	23
Waveforms	23
Electrolytes	24
Flammability	25
Materials	25
Production Line Flow Chart	26
Capacitor Assembly	27
Mechanical Assembly	27
Precautions	27
Terms and Conditions 29	29



Specification, dimensions and drawings are subjected to change without prior information.

Screw Terminal Series

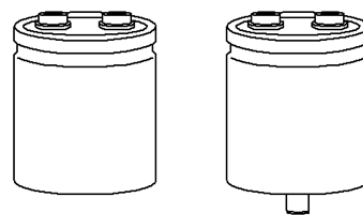

Series	Capacitance Range [μF]	Voltage range [V]	Temperature range [°C]	Case DxH [mm]	Expected lifetime [hrs]	Applications
<u>AR</u>	100-47.0000	40-450	-40°+85° Self extinguishing construction and electrolyte	35x56/76x145	5.000hrs	Industrial applications
<u>AY</u>	1.000-100.0000	40-500	-40°+85° Self extinguishing construction and electrolyte	51x105/90x220	10.000hrs	High reliability Energy storage
<u>AD</u>	2.200 - 22.000	350-450	-55°+85°	51x80/90x220	10.000hrs	High Ripple High reliability Heavy transient Energy storage
<u>AP</u>	1.000-15.000	350-500	-40°+85° Self extinguishing construction and electrolyte	64x105/90x220	12.000hrs	High Ripple Heavy transient Energy storage Solar and wind application
<u>AS</u>	150-330.000	25-500	-40°+85° Self extinguishing construction and electrolyte	35x56/90x220	15.000hrs	Long life High reliability Telecom, Railways applications
<u>AF</u>	1.000-15.000	350-500	-40°+85°	64x105/90x220	20.000hrs	Extra Long life Energy storage Railways applications
<u>AZ</u>	1.000-15.000	160-450	-40°+105°	51x105/90x220	5.000hrs	Wide temperature range Long life High reliability
<u>AT</u>	100-10.000	350-450	-55°+105°	64x105/90x220	8.000hrs	Wide temperature range Very High reliability Very Long Life

Solder Pin Series

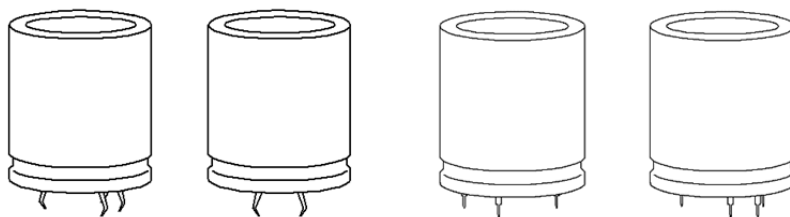

Series	Capacitance Range [μF]	Voltage range [V]	Temperature range [°C]	Case ΦxH [mm]	Expected lifetime [hrs]	Applications
<u>ARC/S</u>	100-3.300	200	-40° +85° Self extinguishing construction and electrolyte	30x40/45x100	2.000	Solder pin mounting Industrial application High reliability 2-4 pins configuration
<u>AKS</u>	100- 47.000	40-450	-40°+85° Self extinguishing construction and electrolyte	30x40/40x100	5.000	Solder pin mounting Industrial applications
<u>ACC ACS</u>	150- 33.000	25 - 500	-40° +85° Self extinguishing construction and electrolyte	30x40/45x100	5.000	Snap-in type, Industrial application High reliability 2-4 pins configuration
<u>AZK</u>	100 - 2.200	200 450	-40° +105°	30x40/40x100	5.000	Solder pin mounting Solar and wind application Energy Storage
<u>AZC AZS</u>	100 - 4.700	200 450	-40° +105°	30x40/40x100	5.000	Solder pin mounting Industrial applications
<u>ATC ATS</u>	100 - 1.500	200 450	-55°+105°	30x40/40x100	8.000	Very Long life Low ESR Solar and wind application
<u>ATK</u>	100 - 2.200	160 450	-55°+105°	30x40/40x100	8.000	Long life Low ESR Solar and wind application

Electrical Characteristics

Capacitance

The DC equivalent circuit of an aluminium electrolytic capacitor is shown in Figure 1

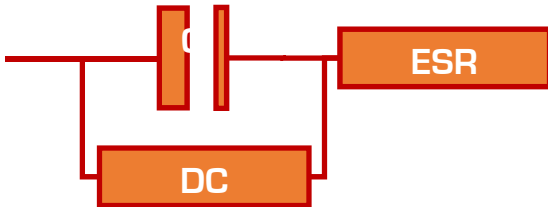

Figure 1

Where:

- DC leakage is the leakage current I .
- C is the capacitance
- ESR is the series resistance

The capacitance of a capacitor is the number of Coulomb/Volt that a capacitor may store. This value is normally expressed in microFarad ($1\mu\text{F}=10^{-6}\text{F}$) and the rated value is marked on the capacitor. The capacitance value depends on the ambient temperature in which the capacitor shall operate: the possible variations for every ITELCOND type are indicated in the graphs of individual data sheets: the largest deviations are at low temperature while at high temperature they are negligible.

It should be mentioned that the capacitance varies not only according to the temperature and frequency but even to the operational life of the capacitor: during the service life of the capacitor capacitance shows a regular decay determined by a series of concomitant causes; such drift is less marked if the operational voltage decreases.

The percent values of capacitance drift for ITELCOND capacitors, after life tests of 2000/5000/10000hrs according to the type, are largely within the tolerance limits indicated in our catalogue and they are definitely lower than stated by DIN or CECC specifications.

Measurement shall be made at frequency of 100Hz and at a temperature of $25^{\circ}\text{C}\pm 2^{\circ}\text{C}$.

Equivalent Series Resistance (ESR)

The equivalent series resistance of a capacitor is the resistance that a capacitor opposes to the passage of the alternating current and represents the "component producing heat when an alternating current is seen by a capacitor". Its percent variation vs. frequency and temperature is shown on Figure 2.

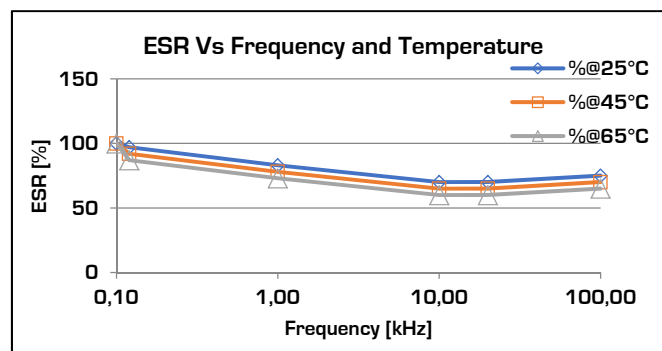

Figure 2

Dissipation Factor (DF)

It is the ratio of the equivalent series resistance to the capacitive reactance as per Equation 1.

$$DF = \text{tg} \delta = \frac{ESR}{X_C}$$

Equation 1

Where the dissipation factor depends on temperature and frequency. Considering Equation 2

$$X_C = \frac{1}{2 \cdot \pi \cdot f \cdot C}$$

Equation 2

the dissipation factor becomes:

$$DF = \text{tg} \delta = 2 \cdot \pi \cdot f \cdot C \cdot ESR$$

Equation 3

This relation shows the variation of the dissipation factor with the ESR and the capacitance.

Measurement shall be made at frequency of 100Hz and at a temperature of 25°C±2°C

Impedance (Z)

The impedance of an electrolytic capacitor depends on capacitance, ESR and ESL in accordance with the Equation 4.

$$Z = 2 \sqrt{\left\{ (ESR)^2 + \left[\left(\frac{1}{2 \cdot \pi \cdot f \cdot C} \right)^2 - (2 \cdot \pi \cdot f \cdot ESL)^2 \right] \right\}}$$

Equation 4

Where:

- E.S.L.is the equivalent series inductance

Superimposed Alternating Current (IRipple)

The superimposed alternating current is the root mean square (rms) value of the alternating current which may be applied to the capacitor. The maximum value tabulated in each data sheets for the different ITELCOND types applies at frequency of 100Hz and ambient temperature of 85 °C, with sine waveforms.

The conversion coefficients given for each type must be applied if temperature and used frequency differ from the conventional one. If, moreover, even the waveform is not sinusoidal the new waveform and the rms values are to be considered.

The maximum value of the alternating current that may be applied to the capacitor shall be determined by

Equation5:

$$P = I_{\text{rms}}^2 \cdot ESR + V \cdot I_f$$

Equation5

The value $V \cdot I_f$ is negligible compared with $I_{\text{rms}}^2 \cdot ESR$ so the above equation can be simplified to Equation 6

$$P = I_{\text{rms}}^2 \cdot ESR = \Delta T \cdot S \cdot \mu$$

Equation 6

giving, finally Equation 7

$$I_{rms} = \sqrt[2]{\Delta T \cdot S \cdot \mu / ESR} = \sqrt[2]{\Delta T \cdot S \cdot 2 \cdot \pi \cdot f \cdot C / \text{tg}\delta}$$

Equation 7

Where:

- ΔT is the difference between ambient temperature and the temperature of capacitor surface [°C]
- S is the capacitor surface [cm²]
- $\text{tg}\delta$ is the value of dissipation factor
- μ is the dissipation coefficient [W/cm²·°C]
- f is the frequency [Hz]
- I_{rms}^2 is the superimposed alternating current [A]
- ESR is the equivalent series resistance [mΩ]
- P is the dissipated power [W]

Temperature variation influences the dissipation coefficient while the dissipation factor (or $\text{tg}\delta$) is influenced by the variation both of temperature and frequency (see par.1.2).

The DIN (41332, 41270, 42348, 41250) and CECC (30300-016 and 30300-017) specifications give the maximum values of superimposed alternating current that may be applied to the capacitor: the values correspond or are inferior to those indicated for the ITELCOND capacitors.

When the ripple current is a sum of rms values at different frequencies, the equivalent current seen by the capacitor is calculated as per Errore. L'origine riferimento non è stata trovata..

$$I_{rms100Hz} = \sqrt[2]{\sum_{f=1Hz}^{nHz} \left(\frac{I_f}{K_f} \right)^2}$$

Equation 8 Where: $K_f = \frac{ESR_f}{ESR_{100Hz}}$

Equation 9

K_f is listed for each product family.

Voltage

Rated Voltage (V_n)

Is the maximum operating voltage for continuous duty at the rated temperature.

Surge Voltage (V_s)

The overvoltages due to transients or peaks due to superimposed alternating component must be always inferior to surge voltage. The surge voltage maximum value for each rated voltage is given in the table of electrical data

Reverse Voltage

Reverse voltage not exceeding 1,5 Volts may be applied to the capacitors without significant change in normal performance characteristics.

NOTE: for special applications (e.g. magnetising equipment) where a certain percentage of reverse voltage shall be applied, capacitors in accordance with customer requirements may be designed.

Expected Life

From the life test and the life test procedure (see introduction) the life expectancy graphs have been drawn. These graphs correlate ambient temperature, applied ripple current and expected life: the ripple current is expressed as a ratio between the ripple current at the ambient temperature and the ripple current at the category temperature.

Marking

ITELCOND capacitors shall be marked as per *Errore. L'origine riferimento non è stata trovata.*

ITELCOND
Series
Rated capacitance [μ F] ¹
Rated DC working voltage [V]
P.N. ²
Date code of manufacture

Table 1

Capacitance Tolerance

Capacitance tolerances can differ in accordance with customer requirement.

Standard tolerances are :

Screw terminal		Solder pins		Customer request
M=±20%	standard	M=±20%	standard	
X=10%,+30%	on request	X=-10%,+30%	on request	A = Special Tolerance

Table 2

Leakage Current

This is the current flowing through the insulation resistance when a direct voltage is applied to the capacitor.

Note: the insulation resistance is the resistance to the flow of a direct current offered by two conductors separated by a layer of insulating material.

Due to the special features of the aluminium oxide layer acting as dielectric, a small current always flows, in electrolytic capacitors, even after applying a direct current for a very long period.

It should be mentioned that a gradual increase of direct voltage applied to the capacitors, till a well fixed value (which must be in no case higher than the working voltage of the capacitor) causes at the two poles of the capacitor a high current flow at first, then the leakage current decreases rapidly as the voltage reaches its maximum rated value.

¹ Capacitance tolerance when different from -10%+30%

² When required

Just after the first sharp decrease the current goes on diminishing in intensity following a nearly exponential curve till it reaches an asymptotic value largely inferior to the initial one.

The curve gradient of the leakage current decrease versus time can be considered as a measure of the quality of the capacitor: the steeper is the curve gradient the better is the capacitor; curves showing a slow decrease of leakage current in a due time indicates that the capacitor doesn't meet high quality standards.

The ITELCOND capacitors of all types, specially the "GENERAL PURPOSE" or the "LONG LIFE" series, have leakage current values largely inferior to the maximum values requested by international and national specifications

Anyway during the first period (minutes) of the equipment turning-on the leakage current rating can be sensibly higher than normal and this is to be taken into account for a correct design of the circuit.

Outgoing Leakage Current

This is the leakage current measured at the acceptance test: in accordance with IEC 60384 the leakage current is to be measured at 20°C after the rated voltage of units has been applied for 5 minutes.

When the ambient (or capacitor's body) temperature differs from 20°C the conversion Table 3 applies.

Operating Leakage Current

Is the leakage current that is reached by the capacitor after a continuous operation.

The maximum limit for operating limit current is to be found on each section.

Leakage Current Multipliers

The leakage current value of an aluminium electrolytic capacitor is influenced by ambient temperature and by ratio of working voltage to rated voltage. Table 3 give some indication of the multipliers that can be generally applied to each series.

Tamb [°C]	AR-AY	AS	AP	AZ	AKS	ACC	AZC/AZK	ATC/ATK
20	1	1	1	1	1	1	1	1
30	1.2	1.2	1.2	1.2	1.2	1.2	1.2	1.2
40	1.4	1.4	1.2	1.4	1.4	1.4	1.4	1.4
50	1.8	1.8	1.6	1.8	1.8	1.8	1.8	1.8
60	2.5	2.4	2.2	2.4	2.5	2.5	2.4	2.4
70	3.5	3.0	2,8	3.0	3.5	3.5	3.2	3.0
85	5.0	4.0	3,9	4.5	5.0	5.0	4.7	4.5
95	N.A.	N.A.	N.A.	6.8	N.A.	N.A.	7.0	6.2
105	N.A.	N.A.	N.A.	9.0	N.A.	N.A.	9.5	8.3

Table 3

Leakage current decrease Vs. Voltage derating

If the voltage applied to the capacitor is lower than the rated one, the leakage current decreases accordingly and the approximate reduction factor is shown in Table 4.

VAPPLIED/VRATED	1	0,9	0,8	0,7	0,6	0,5	0,4
Multiplier	1	0,75	0,70	0,55	0,45	0,30	0,20

Table 4

Leakage Current At Voltage-Free Storage

The capacitors can be stored voltage-free for 2 years at least without any reduction in reliability. If these storage periods have not been exceeded, the capacitors can be operated at rated voltage directly without a re-anodization process.

During the first minutes of the turning-on period, however, the current ratings can be extremely superior to normal ones. This has to be taken into account when designing the circuit.

Due to long period of storage (in particular at high storage and/or high humidity temperature) the leakage current may increase and this phenomenon becomes more noticeable in high voltage capacitors. It's possible, re-applying voltage with a series resistor for a short period (one/two hours could be enough), to re-obtain the initial value.

Storage Temperature

Aluminium Electrolytic Capacitors can be stored up to the maximum category temperature with no voltage applied. It must be considered that storage at high temperature can affect electrical characteristics (namely leakage current) and consequently reliability of the unit. To avoid these undesirable inconvenient, the suggested stock temperature should be higher than +25°C and not exceeding +40°C. Temperature as low as minimum category temperature (-60°C) does not damage the units.

IEC - Climatic Category

The permissible climatic stress on an aluminium electrolytic capacitor is given by the respective IEC climatic category. Following IEC 60068-1, the climatic category is composed by 3 groups of numbers, separated by slashes.

Example 40/85/56.

1st group: Lower category temperature (temperature limit) denoting the test temperature for test A (cold) to IEC 60068-2-1

2nd group: Upper category temperature (temperature limit) denoting the test temperature for test B (dry heat) to IEC 60068-2-2

3rd group: Number of days, the duration of test Cab (damp heat, steady state) at a relative humidity of 93 +2/-3% and an ambient temperature of 40°C, to IEC 60068-2-78

Shelf Life

The shelf life of aluminium electrolytic capacitors is limited and depends from stock conditions.

In a normal warehouse situation (i.e max 35°C, 60% R.H.) the limits as per Table 5 apply.

Years	Limits
1	Units will meet initial electrical parameters level
2	Electrical parameters check is required to understand if re-ageing is required
3-5	Re-ageing is required before use
> 5	End of shelf life

Table 5

Re-Ageing Procedure

The re-ageing procedure must be done @ room temperature and following steps 1. through 5.:

1. connect units to a DC power supply through a resistor of :
 - a. 10k Ω for units having working voltage lower than 100V
 - b. 100k Ω for units having working voltage lower higher than 100V
2. increase the voltage checking that the charging current is not exceeding the maximum initial DC leakage limit of the unit
3. when the rated voltage is reached keep it for at least 4(four) hours
4. discharge the unit through a 10kW keeping voltage decrease under control until discharge is complete
5. test units for DC leakage according to the specification

Important

When performing re-ageing operation of units keep in mind the operator is exposed to live voltage if unit is not properly insulated from surrounding. When operator is handling units he must wear insulating gloves and glasses to prevent any body damage due to possible and sudden unit explosion

Reliability

Technical data given for capacitors of different ITELCOND types agree with CECC norms (where applicable and/or available) following Table 6.

Series	CECC
Screw terminal type	30301-802/807/810
Solder pin type	30301-805/808/809/811

Table 6

The relative failure rate given in DIN specifications and fully met by ITELCOND capacitors of different series are reported here below in Table 7.

General Specification Requirements		
Working Voltage	Failure Rate	Series
<25Vdc	0.5%	Long life
30<Vdc<450	0.2%	Long life
6.3<Vdc<450	2.0%	General use

Table 7

In the following paragraphs there are the main terms occurring when considering problems concerned with reliability. It should be considered that the values each parameter assumes in reliability are statistical figures and so they are valid only if great numbers or lots are considered.

Operational Life

The Operational Life is the period of time in which a capacitor reaches the maximum accepted values of modification of its electrical parameters.

To forecast the predictable operational life, MIL-STD-690 specifications with a "confidence level" of 60% (see next paragraph) are considered.

The following Figure 3 and Figure 4 based on before said specifications, indicate both the "failure rate" versus the testing time and the way to forecast the likely "failure rate" versus the number of "unit-hour", the "confidence level" and number of faulty ones.

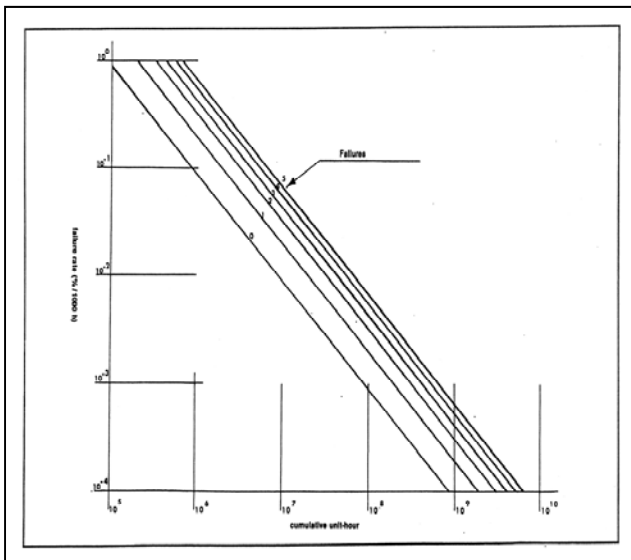

Figure 3

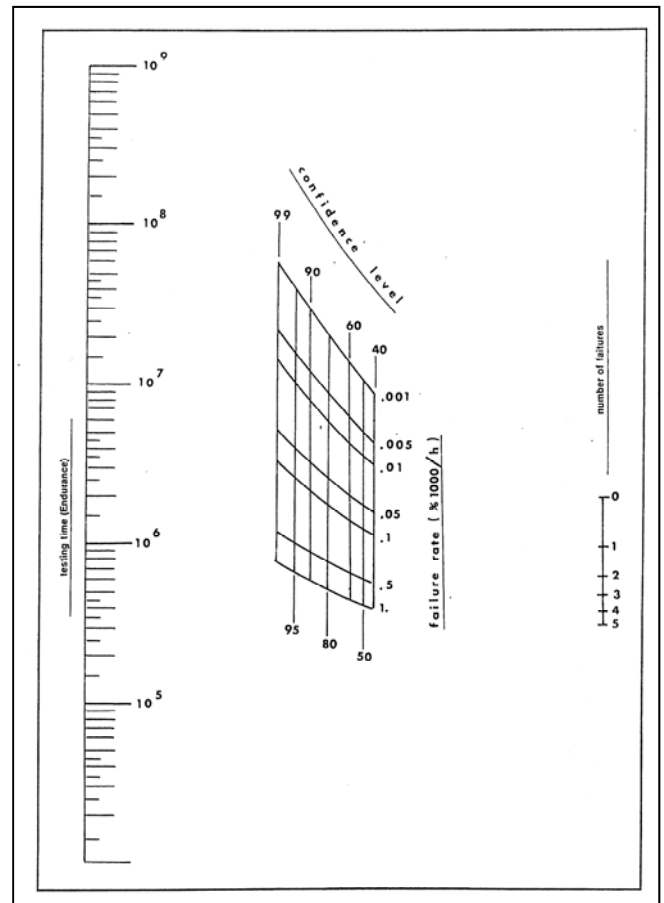

Figure 4

Figure 4 shows the relation among the various factors already considered:

- Unit-hours
- Confidence level
- Failure rate
- Number of defective units

Example: it may be considered, for example, a test period of 10^8 unit-hours, in which only a defective unit has been found on all the samples tested. If a line between the scale of the component-hours (10^8) and the scale of the faulty ones is drawn, the different combinations between "failure rate" and "confidence level" can be obtained, as per Table 8:

Failure Rate	0.005	0.004	0.002
Confidence Level	95%	90%	60%

Table 8

Clearly the same nomogram (based on MIL-STD) can be used to obtain the lowest number of "component-hour" to predict the maximum number of defectives with a certain confidence level etc.

For every ITELCOND type for which a rated operational life is given at rated temperature the figures in the detail section show the variation of the operational life according to a certain decrease of the ambient temperature on a load of full category voltage; obviously a decrease of the ambient temperature and a reduced voltage improve the given data.

As a further guarantee it should be mentioned that:

- Every series of capacitors undergoes regularly operational life test for a period of time longer than that in catalogue
- The variations of the electrical parameters found at the end of the before said ITELCOND tests, are well within the limits given for the individual types at the end of standard internal tests.

Confidence Level

The term "confidence level" indicates a probability that a component will fail the homologation when its assessed failure rate is equal to the failure rate required for the homologation.

Assessed Failure Rate

The term indicates the failure that should be found if all the units produced in a process "under control" would actually be tested.

NOTE: a "under control process" is a process in which there are random variations of the average failure rate

Failure Rate (λ)

The failure rate is the number of failed units indicated in percent for every 1000hrs test: this definition is valid only for a well-defined confidence level. The failure rate values depends on ambient temperature and on ratio of applied voltage to rated voltage.

Reference conditions are given in Table 9.

T [°C]	V _{applied} /V _{rated}
40	0,50

Table 9

Figure 5 shows the variation of λ (or fit, see next paragraph) versus applied voltage (in %).

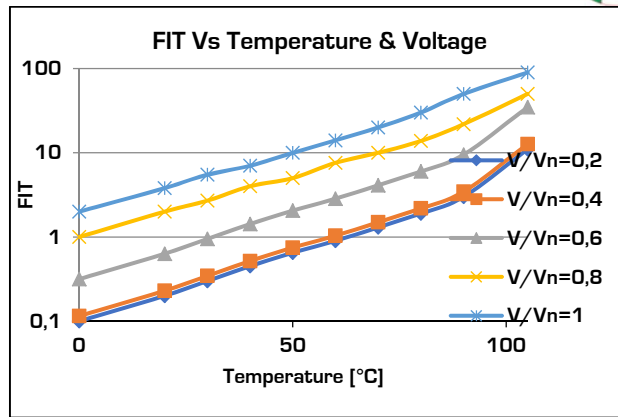

Figure 5

Failure in time (FIT)

FIT is the general expression of the failure rate with a confidence level of 60 % (MIL-STD-690) as per Equation 10 and Equation 11, a sample of calculation is reported in Equation 12.

It's a calculation from field observation and results of periodical tests in our laboratory.

The failure rate mainly depends from failure criteria and the operating and ambient conditions.

$$\text{FIT} = \frac{\text{number of failures (confidence level 60\%)}}{\text{(tested components} \cdot \text{test duration)}} \quad \text{Equation 10}$$

$$1\text{FIT} = 1 \cdot 10^{-9} \text{hrs} \quad \text{Equation 11}$$

Example:

$$100\text{FIT} = 1 \cdot 10^{-7} \text{hrs} = 0,01\% \cdot 10^{-3} \text{hrs} = 0,01\% / 1000\text{hrs} \quad \text{Equation 12}$$

Typical FIT Values

Years of experience have shown that values in Table 10 can be considered, during the intrinsic failure period of a typical bathtub statistical curve.

ITELCOND series	Voltage	FIT	ITELCOND series	Voltage	FIT
AR,AY	<150 Vdc	40	AZK	<150 Vdc	50
	≥150 Vdc	70		≥150 Vdc	80
AS	<150 Vdc	45	ATK	<150 Vdc	40
	≥150 Vdc	45		≥150 Vdc	70
AP	ALL VOLTAGES	45	ACC	ALL VOLTAGES	50
AF	ALL VOLTAGES	45	AZC	<150 Vdc	50
AT	ALL VOLTAGES	20		≥150 Vdc	80
			AKS	<150 Vdc	50
				≥150 Vdc	70

Table 10

Mean Time Between Failure (MTBF)

The MTBF is given in Equation 13.

$$MTBF = 1/\lambda$$

Equation 13

where λ is the failure rate.

Mean Time To The First Failed Component (MTTF)

The value of MTTF is given in Errore. L'origine riferimento non è stata trovata.

$$MTTF = 100'000 / (\% / 1000\text{hrs}) = 100'000 / \lambda$$

Test

Shelf Test

Capacitors shall be subjected to the maximum operating temperature $\pm 1^\circ\text{C}$ for 96 ± 4 hours.

No voltage shall be applied and the electrical parameters must be within the specified range (see IEC 68-2-2 and subq.)

Surge Voltage Test

The capacitor shall be subjected to 1000 cycles each consisting of 30s charge, followed by a no load period of 330s at surge voltage, as defined in detail specification. Test temperature is room temperature for general use capacitors and upper category temperature for long life capacitors. A series resistor must be connected to the capacitor with a value of:

- 1000Ω for $C < 3300\mu\text{F}$
- $2,5 \cdot 10^6 / C \Omega$ for $C > 3300\mu\text{F}$

After test, a recovery period of 2hrs is required before taking any measurement. The requirements are:

- no electrolyte leakage,
- leakage current lower than stated limit
- tangent of the loss angle lower than stated limit
- $\Delta C / C < 15\%$ (CECC 30300-4.14)

Vibration Test

Screw Terminals

To IEC 60068-1:

Frequency range 10 Hz / 55 Hz, displacement amplitude 0,75 mm, acceleration max 10 g, duration 3 x 2 h.

Capacitor mounted by its body which is rigidly clamped to the work surface.

Solder pins

To IEC 60068-2-6, test Fc:

Frequency range 10 Hz / 55 Hz, displacement amplitude 0,35 mm, acceleration max 5 *g*, duration 3 x 2 h.
 Capacitor mounted by its body which is rigidly clamped to the work surface.

Sealing Test

The capacitors shall be tested for seal tightness in accordance with IEC 68-2-17.

Low Pressure

In accordance with IEC 60384-4 subclause 4.11.4 capacitors can operate at a minimum pressure of 8.5 kPa for short period.

Important:

- Continuous operation at extreme altitude can impair useful life.
- The capability to withstand to low pressure is for unit mounted in accordance with related specification.

Life Test

Life Test Procedures

The following notes are intended as a clarification of tests employed at ITELCOND Quality Control Laboratory to ascertain the quality of the finished products along the years. The life test duration for each series is in accordance with IEC 60384-4 requirements.

LONG LIFE SERIES = 2000 hours at maximum category temperature

GENERAL USE = 1000 hours at maximum category temperature

In addition, ITELCOND quality program provides that life tests are performed for a minimum number of hours, usually higher than required by IEC, in accordance with Table 11.

Series	Working Voltage	Temperature	Hours of test	Series	Working Voltage	Temperature	Hours of test
AR	<150	85°	2000	AKS	All voltages	85°	2000
AR	>150	85°	2000	AZK	All voltages	105°	2000
AS	<150	85°	10000	ATK	All voltages	105°	2000
AS/AP	>150	85°	5000	ACC	All voltages	85°	2000
AF	>150	85°	5000	AZC	All voltages	105°	2000
AY	All voltages	85°	2000	ATC	All voltages	105°	2000
AZ	All voltages	105°	2000				
AT	All voltages	105°	5000				

Table 11

From the data obtained performing these life tests ITELCOND Quality Control had the possibility to draw the tables shown for each series. The "EXPECTED LIFE TABLES" are calculated with the same "electrical parameters changes" used for life test procedure and shown here below.

Electrical Parameters Change

The electrical parameters variations during life test are strictly connected with the quality of finished units and must be within maximum limits given in Table 12

Working Voltage	Capacitance Change	Tanδ/ESR Change	I Leakage Change
Screw inserts			
2.000 hrs			
<150V	±15%	1,3 • data book limit	Less than initial specified limit
≥150V	±10 %	1.3 • data book limit	Less than initial specified limit
5000 hrs			
<150Vdc	±15 %	1.3 • data book limit	Less than initial specified limit
≥150Vdc	±15 %	1.3 • data book limit	Less than initial specified limit
10.000 hrs			
< 150 Vdc	±15 %	1.5 • data book limit	Less than initial specified limit
Solder Pins			
All voltages	±10 %	2.0 • data book limit	Less than initial specified limit

Table 12

The above electrical parameter changes are considered as final limits when the expected life curves are drawn. From the data obtained performing these life tests ITELCOND Quality Control had drawn the tables named "Expected Life Tables" and shown for each series. The "Expected Life Tables" are calculated with the same "electrical parameters changes" used for life test procedure and here indicated.

The expected life values that appear on standard graphs must be multiplied by 2.0 for all series if the parameter's change is in Table 13.

Quantity	Working Voltage<150V	Working Voltage≥150V
Capacitance	±15%	±10%
ESR	≤3 • data book limit	≤3 • data book limit
DC	≤Data book limit	≤Data book limit
Total failure in percent	≤1%	≤3%

Table 13

Operational Life Time and Voltage Derating

Operating life time depends on the capacitor general working conditions; if the capacitor is subjected to a temperature or to a voltage lower than rated [see par.1.8] there is a consistent increase in life. Assuming that life is doubled at every temperature decrease of 10°C, when the applied voltage is lower than the rated one the expected life increase is shown on Graph 1 and Graph 2.

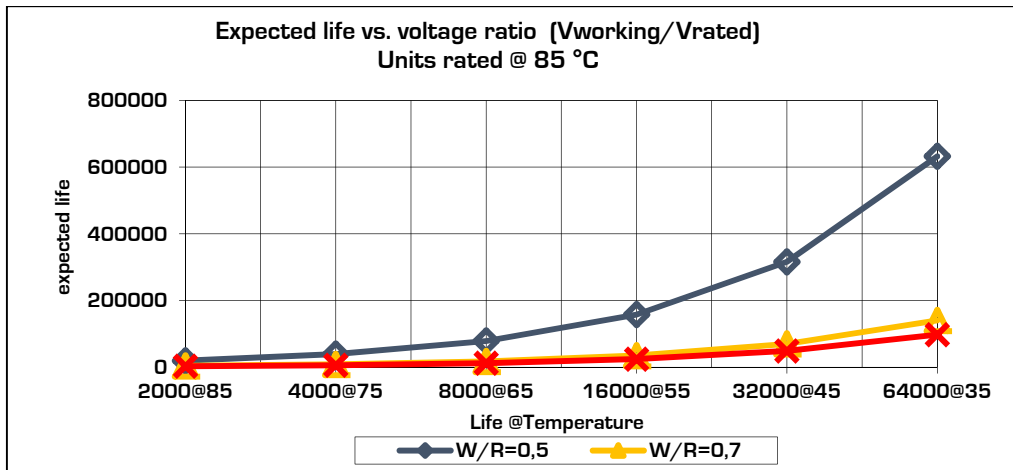

Graph 1

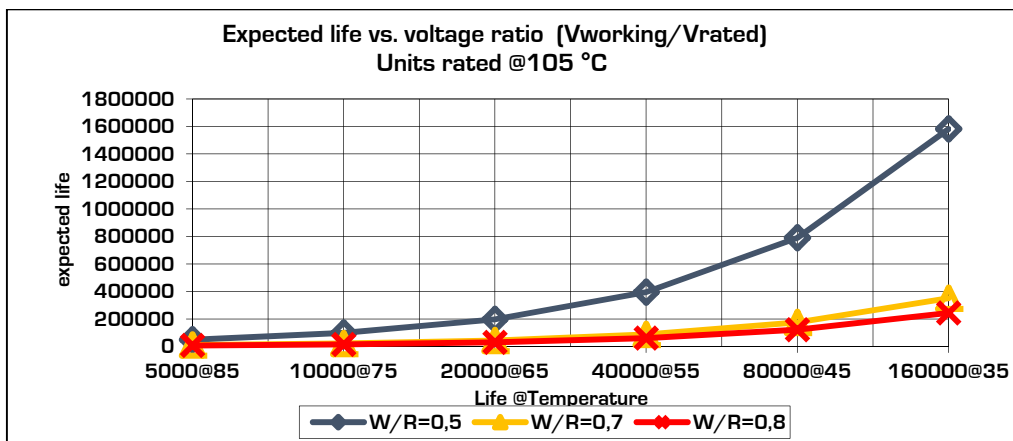

Graph 2

Useful Life Calculation

The useful life of a capacitor is calculated in accordance with the tables of expected life per each series.

The rated ripple current at upper category is listed in the data sheets, while the ripple current at different temperature can be calculated using the tables shown on each series.

To know the useful life proceed as follows :

- calculate the ratio $[I_r]/[I_{85^\circ\text{C}}]$ or $[I_r]/[I_{105^\circ\text{C}}]$
- find on to the table the crossing between the working temperature an the calculated ratio
- on top of the table it appears the useful life in hour

The example does not consider the frequency dependence of ripple current : the corresponding factor listed on each type must be used as an additional factor.

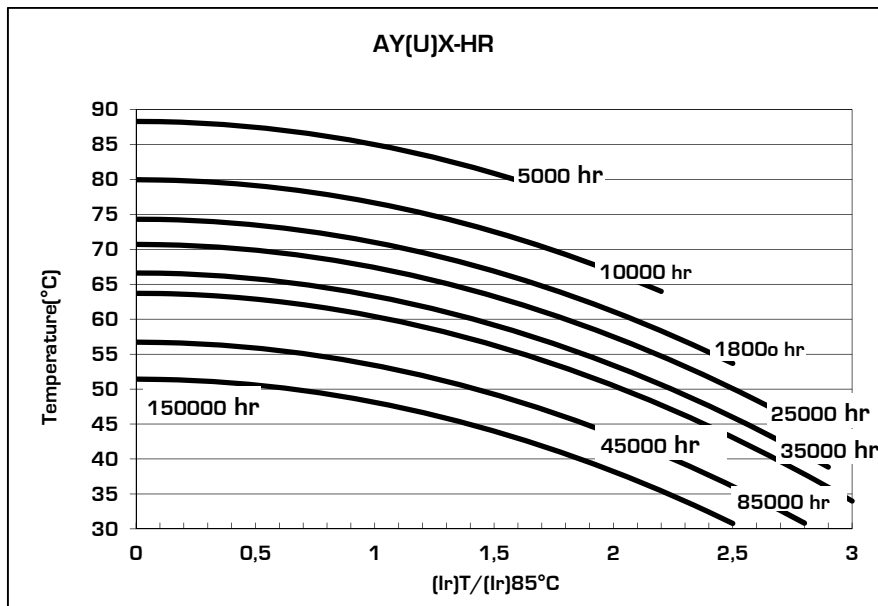

Example 1:

- Capacitor AY(U)X-HR472M350DF1
- Working conditions: $I_{Ripple} = 25A @ 100Hz$
- Ambient temperature = $70^{\circ}C$

VN=350V

Capacitance	Case	Tanδ	ESRmax/typ		Zmax	Iripple55°C/85°C		Ordering Code
[μF]@100Hz		[%]@100Hz	[mΩ]@100Hz		[mΩ]@10KHz	[A]@100Hz	[A]@100Hz	(U) for mountig stud
4700	DF	0,08	27	20	17	23,9	17,1	AY(U)X-HR472M350DF1

1. $\frac{I_{Ripple}}{I_{Ripple@85^{\circ}C}} = \frac{25}{17,1} = 1,46$

a. Crossing 1,46 and $T=70^{\circ}C$ expected life is about 10000 hours

Example 2:

- Capacitor AY(U)X-HR472M350DF1
- Working conditions: $I_{Ripple} = 25A @ 500Hz$
- Ambient temperature = $70^{\circ}C$

VN=350V

Capacitance	Case	Tanδ	ESRmax/typ		Zmax	Iripple55°C/85°C		Ordering Code
[μF]@100Hz		[%]@100Hz	[mΩ]@100Hz		[mΩ]@10KHz	[A]@100Hz	[A]@100Hz	(U) for mountig stud
4700	DF	0,08	27	20	17	23,9	17,1	AY(U)X-HR472M350DF1

1. $I_{\text{Ripple}} = \frac{25}{1,32} = 18,9$

2. $\frac{I_{\text{Ripple}}}{I_{\text{Ripple}@85^{\circ}\text{C}}} = \frac{18,9}{17,1} = 1,10$

a. Crossing 1,10 and T = 70 °C expected life is about 14000 hours

Example 3:

- Capacitor AY(U)X-HR472M350DF1
- Working conditions: IRipple=25A@500Hz
- Ambient temperature =60°C

VN=350V

Capacitance	Case	Tanδ	ESRmax/typ		Zmax	Iripple55°C/85°C		Ordering Code
[μF]@100Hz		[%]@100Hz	[mΩ]@100Hz		[mΩ]@10KHz	[A]@100Hz	[A]@100Hz	(U) for mountig stud
4700	DF	0,08	27	20	17	23,9	17,1	AY(U)X-HR472M350DF1

3. $I_{\text{Ripple}} = \frac{25}{1,32} = 18,9$

4. $\frac{I_{\text{Ripple}}}{I_{\text{Ripple}@85^{\circ}\text{C}}} = \frac{18,9}{17,1} = 1,10$

a. Crossing 1,10 and T =60 °C expected life is about 36000 hours

Capacitor Connection

The aluminium electrolytic capacitors can be connected in parallel : the connection must e as such that the current flows equally through each unit

The aluminium electrolytic capacitors can be connected in series: use balancing resistors to control the voltage distribution across each unit.

For more detailed information contact our engineering service

Insulation Strenght

-Insulation resistance @100V, 60". between terminals and mounting hardware □100 MΩ.

-Dielectric strength of the sleeve □2500Vdc.

Self recharging (Dielectric Absorption)

It is important to take note that Aluminium Electrolytic Capacitors undergo to the phenomenon of self recharging .

Generally speaking it is impossible to give a precise rule to predict which voltage an unit, even when completely charged and discharged, can reach if left open circuit.

Itelcond has observed a maximum of 30 volt across the terminals but sometimes the value could be higher and not predictable.

It is therefore suggested to discharge the units before touching or connecting the terminals.

Cleaning Agents

Halogenated solvents are not recommended for use in cleaning capacitors, while many solvents such as alcohol are suitable. It must be remembered that many solvents given, as chemically stable in the most varied conditions may on the contrary be electrochemically dissociated, producing chemical products extremely dangerous to the capacitor life. The following list contains critical halogenated solvents (unsafe) used as cleaning agents in electrical industry: Trichloroethane (ex. Chlorotene)

- Freon
- Trichloroethylene
- Tetrachloroethylene
- Chloroform
- Methylene chloride
- Methyl ethyl Ketone
- Acetone

In case of wetting capacitors with those solvents, a safe cleaning agent must be used to eliminate residues of non-safe agents.

List of solvents without halogen (safe):

Methanol

Propanol

Isobutanol

Databook Ordering Code

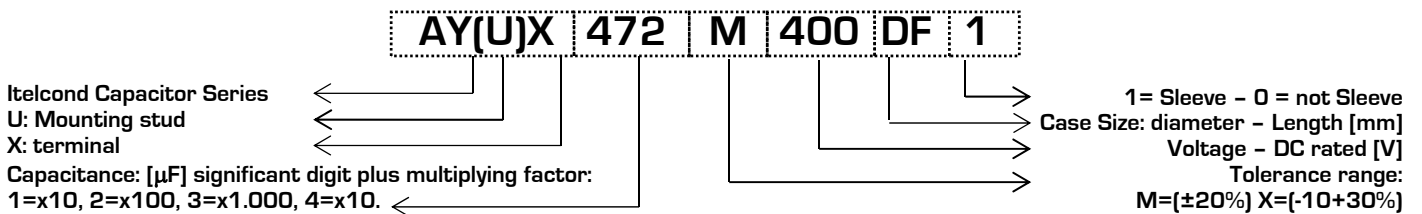

Packaging

Units are packed in cartoon boxes and the number of units per box is in accordance with following table. Units are packed in cartoon boxes and EUR dimensions wooden pallet (plastic on request).

Series	Diameter	Length	Pcs/Box	Weigth/Box [kg]
Screw terminal	A 35mm	A=55mm	50/100	4-7
		B=80mm	50	4-6
		C=105mm	50	6-8
	B 51mm	B=80mm	30	5-7
		C=105mm	30	6-9
	C 63mm	C=105mm	20	6-8
		F=145mm	20	9-10
	D 76mm	C=105mm	12	5-7
		F=145mm	12	6-14
		K=165mm m	12	6-14
		J=222mm	8	9-11
	E 90mm	C=105mm	6	7-9
		F=145mm	6	9-11
J=222mm		6	8-12	

Table 14

Series	Diameter	Length	Pcs/Box	Weight/Box [kg]
Solder pins	M 30mm	B=40mm	100	4-6
		C=50mm	100	4-6
	N 35mm	B=40mm	100	6-8
		C=50mm	100	6-8
		N=60mm	50	5-7
	P 40mm	E=75mm	50	6-8
		B=40 mm	126	9-10
		C=50mm	126	9-10
	Q 45mm	E=75mm	63	10-11
		G=100mm	63	10-11
		C=50mm	30	6-8
		E=75mm	30	7-9
		G=100mm	30	8-10

Table 15

The shown weight values depend from the type of unit packed into the box : the weight of units is a function of the capacitance value of the capacitor (e.g. into the same can size a capacitor having a capacitance of 2200µF units differs substantially from one having a capacitance of 10000µF.

Waveforms

The Fig.8 indicates the most popular waveforms and the applicable current both as average and rms. value.



Waveform	R.m.s value	Waveform	R.m.s value
	$A \cdot \sqrt{\frac{T}{3}}$		$A \cdot \sqrt{\frac{t_1}{3 \cdot T}}$
	$A \cdot \sqrt{\frac{T}{t_1}}$		$A \cdot \sqrt{\frac{(2 \cdot D + 3 \cdot T)}{t_1}}$
	$A \cdot \sqrt{\frac{T}{2 \cdot t_1}}$		A

Table 16

Electrolytes

Electrolytes used in aluminium capacitors manufacturing are produced in accordance with Itelcond internal specifications

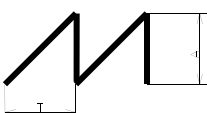
Since its foundation ITELCOND never used in its electrolytes formulation dangerous or potentially poisonous chemicals. So all electrolytes were and are free from:

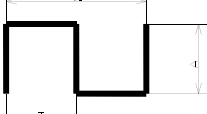
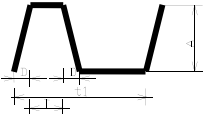
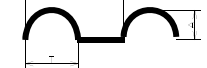
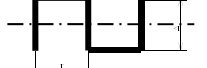
Dimethylformamide (DMF)

Dimethylacetamide (DMAC)

Polychlorinated byphenil (PCB)

Non Flammable Materials

Raw Material For Screw Terminal

ITELCOND capacitors can be manufactured with outside raw materials that can meet UL specifications: more precisely

Component	Material	UL rating
Cover	Thermosetting	VO
Plastic sleeve	PVC	VO
Bottom insulating disk	PVC	VO
Plastic washers	Thermoplastic	VO
Hex nut	Thermoplastic	VO

Table 17

Raw Material For Solder Pin Types

The above concept can be also applied to all series having solder pins.

Component	Material	UI rating
Cover	Rubber-bakelite	HB
Plastic sleeve	Pvc	VO
Bottom insulating disk	Pvc	VO

Table 18

Flammability

These notes are intended to clarify the “*flammability concept*” that is concerning most of Aluminium Electrolytic Capacitors users

Considering fire and possible fire hazard, the design engineer should know that: *UL detail specification concerning DC Aluminium Electrolytic Capacitors doesn't exist*

UL specifications cover fire hazard and test on not flammable material.

The test that can be used to control outside material used in Aluminium Electrolytic Capacitors European is covered by the specifications (IEC 60695-2-2)

The tests done on finished capacitors are to be considered useful only for comparison as it strongly depend on material dimensions and also by other materials that can be in contact: external material itself are UL approved as VO or HB rated

Under standard applications (when soldering heat is not in excess, if the beading is not damaged, if an abnormal use conditions are not applied, if there has been an incorrect polarity application etc.) there is no leakage of the liquid that impregnates the rolled section (“the capacitor’s body”): if that happens and if there is a possible fire source around the unit the ignition of the rolled section can start and will continue until the fire (or the flame or whatsoever is the possible ignition reason) stays in contact with the inside part of the capacitor.

As soon as the fire source is removed the rolled section stops to burn generally in less than 15 seconds.

It is of great importance to underline that the fire stops as soon as the source is removed ; if source of fire is newly applied the fire can restart.

Materials

To the best of Itelcond knowledge Aluminium Electrolytic capacitors manufactured in his plant complies to :

Directive 2002/95/EC -January 2003

Amendment of Directive 2002/95/EC -August 2005

Directive 2003/11/EC -February 2003

Directive 2006/122/EC -December 2006

Itelcond certificates that during designing and/or manufacturing of aluminium electrolytic capacitors no :

Asbestos

Polychlorinated Triphenyl (PCT)

Lead (Pb)

Polybrominated Biphenyl (PBB)

Mercury (Hg),

Polybrominated Diphenyl (PBD)

Dimethylacetamide (DMAC)

Chromium VI (Cr^{VI})

Dimethylformamide (DMF)

Polybrominated Diphenyl Ethers(PBDE)

Polychlorinated Biphenyl (PCB)

PentaBDE / OctaBDE / DecaBDE

Materials currently listed as carcinogenic / mutagenic / teratogenic are not intentionally added or used.

Itelcond received also written assurance from suppliers that they don't use the above chemicals or substances in the manufacture of products Itelcond is currently buying to produce its own component.

Production Line Flow Chart

The figure 10 shows the aluminium electrolytic capacitor flow chart.

It has to be observed that all materials come from approved suppliers and cannot be used in production line unless specifically approved. All scrapped chemicals and/or electrolytes are stored in a controlled area and are sent to a plant that can treat them avoiding soil and water pollution.

Same procedure (as per ISO EN 14001 requirement) is followed for finished units or raw materials that must be, for some reasons, scrapped.

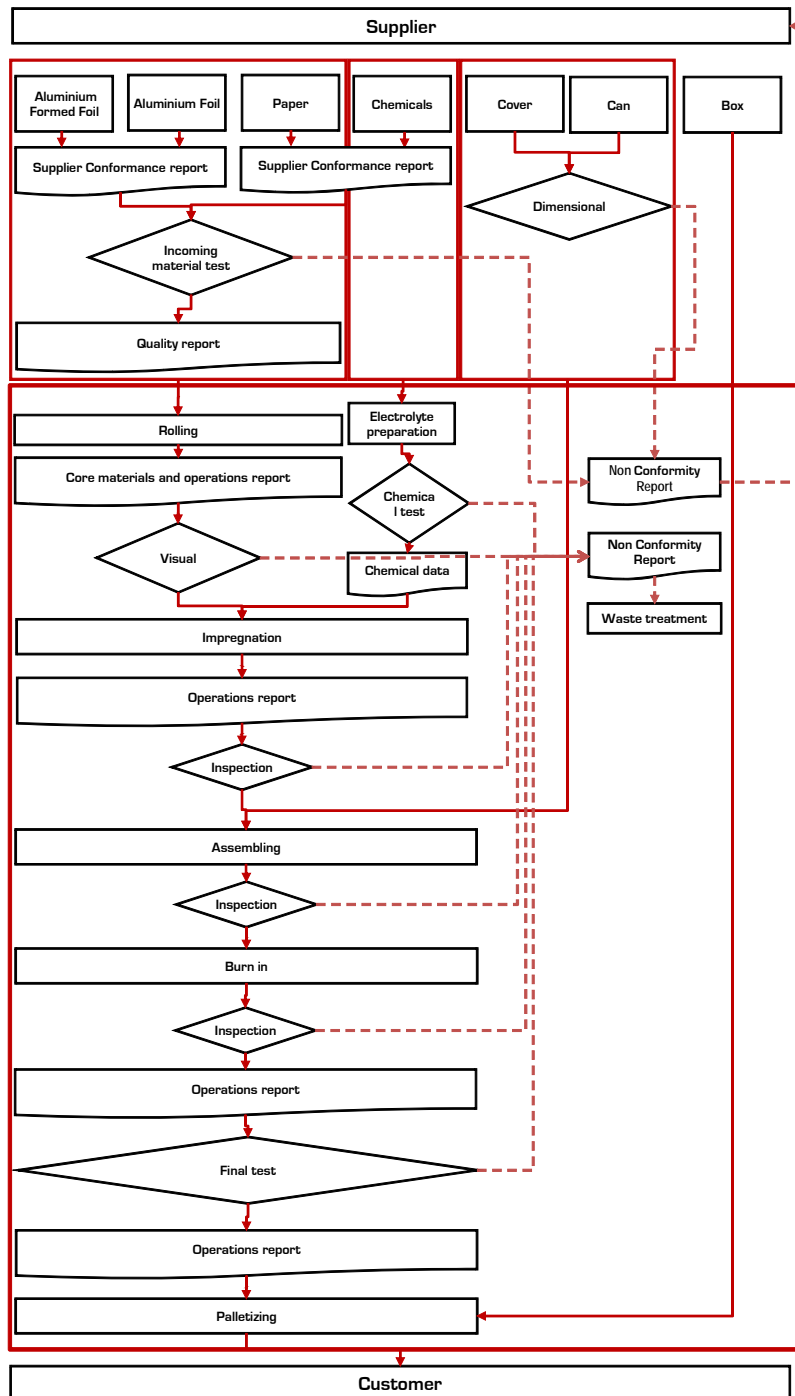

Figure 6

Mechanical Assembly

- When using high-capacitance and high-voltage electrolytic capacitors it is important to remember that the inner part (the rolled section) is not insulated from can: between the negative pole and the aluminium can there is a variable and not defined resistance essentially due to the electrolyte used in capacitor manufacture.
- Capacitor mounting must be apt to ensure that the terminals do not point downward (see Fig.13). In case of horizontal mounting the safety vent must be put in the shown position.

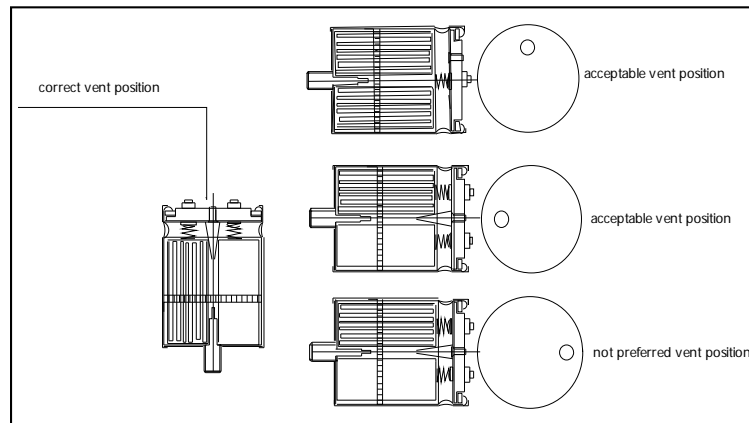

Figure 7

- Do not mount screw terminal capacitors downward : if that the case be sure that there is a venting hole in PC board
- Spacers (paper) and electrolyte present in aluminium electrolytic capacitors are flammable
- The electrolyte used in capacitors production are highly conductive and contains ammonia or ammonium salt in different forms : possibly leaking electrolyte can slowly corrode the copper paths on PC board.

Precautions

When using aluminium electrolytic capacitors a number of precautions must be taken :

- Operating temperature ,ripple current and working voltage must be within the specified limits
- Don't apply any reverse voltage or AC to the capacitors :there could be abnormal increase in temperature and even explosion of unit
- When protection against reverse voltage is required please contact our engineering.
- In any case AC cannot be applied
- Capacitors that undergo (occasionally or purposely) to reverse voltage cannot be used any longer
- DC voltage plus AC component cannot exceed the working voltage of the unit
- Capacitors to be used in areas where there are harmful gases will undergo to a life reduction due to damages that can occur to sealing rubber or to gasket : the damage of these parts can cause the gas enter into the capacitor with consequent corrosion of capacitor's body
- When capacitor is used a highly dusty area check that the level of powders on the top of the unit is not overpassing insert shoulder height to avoid possible short circuit between plus and minus pole

- **Moisture or salt spray can penetrate into the capacitor and cause short circuit of the unit**
- **When mounting screw terminal capacitors see par. 16**
- **When mounting snap in capacitor with a solder iron the hot tip cannot come in contact with the can, cover material or insulating sleeve**
- **When units are mounted on series – parallel use homogeneous date codes**
- **Handling of capacitors must be done carefully : unit falling on the floor or bumping against object can be damaged even when no particular visible modification of unit can be seen; if it happens replace units**
- **Capacitors cannot be stored under direct sun light**
- **To avoid electrical shock read carefully par. 6**
- **When an unit operates for long time at voltage consistently low and then sees an high voltage an increase in temperature must be expected**
- **When a snap in unit is fixed to the pwb by means of fixing material be sure that the fixing compound do not contain chloride or chemicals that can deliver chlorine during polymerisation process**
- **Cleaning circuit must be done with safe chemicals (see par. 7)**
- **Harzadous voltage specially on very high capacitance units is present for up to 60 minutes after disconnection from power supply**
- **Do not use capacitors having standard design in circuits where charge and discharge cycles have an high repetition rate; specific capacitors can be designed for this application**
- **When safety vent operates a gas at high temperature is emitted : the gas is driving out from capacitor boby some electrolyte that could damage the PC board or connecting bars not properly insulated from chemical attack.**
- **When a capacitor in bank fails check all capacitors and replace them : don't replace failed unit only**

Terms and Conditions

1. The general conditions presently in force are applicable to all purchases effected by the Client (Buyer) from Itelcond S.r.l. (Seller). These general conditions must not be exceeded, modified, deferred or, in any other way, altered, except if an official document is underwritten and signed by the Seller. Under no circumstances the general conditions adopted by the Buyer, printed on his purchase orders or any other document, will be deemed applicable to none of the purchase orders placed with the Seller. The execution, also partial, of the Buyer's order, or any other fulfilment from the Seller's side towards the Buyer, will not be valid and therefore not interpreted as tacit or implicit acceptance of any general condition decided by the Buyer, unless specifically agreed upon the Seller's legal representative.
2. The products manufactured or sold by the Seller are not designed to be used into devices or equipments to be inserted surgically into the human body or, in other words, suitable to examine or preserve the human life, or used in devices or systems for the nuclear applications. If the Buyer intends to utilise the Seller's products for its application in medical, nuclear, military and/or aerospace fields, he may do so only with prior request and receipt of a document signed by the Seller's managing director, certifying that these products are suitable to be applied in the above fields,
3. The Seller will accept purchase orders only after written confirmation of the order, sent to the Buyer.
4. Delivery dates shown in the confirmation order are only indicative and not binding. The Seller will do his utmost in order to respect the confirmed delivery date but, at the same time, does not take any responsibility for the eventual non-observance of the date. The delivery is linked to the payment of eventual amounts which are due and are related to previous supplies. Likewise also prices indicated in the confirmation order might vary according to increases in the energy or raw materials prices or changes in currency rates.
5. In absence of written agreements, orders are considered fulfilled with a tolerance of plus/minus 3% or plus/minus 5 pieces.
6. The technical specifications of the Seller's products are those contained in his last "Data Book" and are also traceable on his Web Site: www.itelcond.it. The technical specifications may also be those agreed upon between Seller and Buyer.
7. Seller's products will be free from vices and will be guaranteed for a period of 12 months from delivery date to the Buyer. The law decree No.24 of 02/02/2002 will not be enforced as these products are not considered as consumer goods. The warranty is effective exclusively towards the Seller's direct Buyer. Damages claimed by third parties, although if requested by Seller's direct Buyer, will be turned down.
8. The warranty does not cover products which are used incorrectly. Certain types of electric products, designed and manufactured to be used as basic components to be inserted in other electric devices, are anyway such that their performance is widely related to the way they are integrated in the final product and by its general characteristics. In the range of these basic components are included both active and passive components and notably the electrolytic capacitors.
9. Eventual defects or vices of goods will be promptly notified in writing and anyhow not after 8 days from the date of receipt of goods. In case of hidden defects, the above timing will start from the date of the discovery of these defects. In case of vices ascertained and reported in due time, defects or lack in quantity or quality of products, the Seller is entitled to the sole substitution of such products, repair or writing back of such products at his choice. In line with the most ample applicability of the law, any different and further responsibility is excluded for damages occurring to the buyer or third parties with regard to the utilization of the Seller's products. Samples, prototypes and products in development, will be delivered as they are and uncovered from warranty.
10. In case of missed and damaged products and units considered not in line with the technical specifications, the Buyer is entitled to inform immediately the Seller, who will decide how to proceed about the matter. No rejected goods will be accepted, unless previously authorized by the Seller. If an authorization number for the rejection (RMA) has been notified to the Buyer, such a number must be reported both on packaging and on documents accompanying the units rejected to the Seller. Products, travelling at Buyer's risk and danger, must be returned complete, not tampered with, non welded, with their eventual accessories and adequately packed and delivered free factory of Seller. The assignment of the authorization number for rejection does not allow the Buyer to obtain the substitution of products, the credit of their value, and whatsoever responsibility on the Seller's side is not admitted. The Buyer is obliged to comply with the rules related to the re-exportation of the products to clients or countries, if the Italian law forbids export and sale towards them.
11. Goods are sold free factory of Seller and therefore the transportation risk is at total Buyer's charge. The delivery of products will be considered in every respect accomplished once the products are collected by the carrier or by the same Buyer at the Seller's warehouse.
12. The sold products will remain property of the Seller until totally paid by the Buyer. In case of delayed or missed payment the Seller may, at his discretion, request to re-enter into possession of unpaid products.
13. The Seller will not be liable if events, not due to his will, will prevent him to accomplish, partially or totally, the contractual obligations undertaken. The Seller will not assume responsibility for his products after the same are assembled on Buyer's equipments. The Seller will not be liable, no limitations admitted, for damages caused by the loss of warranty, contracts, or other legal matters, including loss of value, profit, capital, or expenses for the substitution of equipments.
14. Any dispute will be submitted to the law-court of Milan (Italy). Under any circumstance the contract will be exclusively governed by the Italian law.

Notes
